



Equipment Manual



RoofTracker IIITM

Roof Truss Roller Press

Copyright © 2017 MiTek®. All rights reserved.
Patented. See Legal Notice for list of patents.

001068 rev. A

Manual applies to U.S. equipment.

*If printing this manual from a file, it is highly recommended that it be printed in high resolution in color ink.
Many of the graphics will be unclear and could create an unsafe condition if this recommendation is not followed.*

Equipment Manual

RoofTracker IIITM

Roof Truss Roller Press



U.S. and other patents pending.

*Manual applies to U.S. and
International equipment.*

MiTek Machinery Division
301 Fountain Lakes Industrial Drive
St. Charles, MO 63301
Phone: 800-523-3380
Fax: 636-328-9218
www.mii.com

Part # and Rev.	001068 rev. A
Revision Date	1 November 2017
Revised By	G. Gaia
Approved By	M. Kanjee
Print Date	1 November 2017
Orig Date Created	2 January 2017
Created By	G. Gaia
Applicability	67390-501 67390-601
Effectivity	15 December 2016

Legal Notice

Patents

Made and sold under one or more of the following patents:

U.S. 4,986,052	U.S. 5,837,014	U.S. 6,219,975
U.S. 5,385,339	U.S. 5,854,747	U.S. 6,260,263
U.S. 5,493,834	U.S. 5,873,567	U.S. 6,317,980
U.S. 5,568,862,	U.S. 5,884,448	U.S. 6,389,762
U.S. 5,630,697	U.S. 5,885,731	U.S. 6,401,422
U.S. 5,636,494	U.S. 5,906,264	U.S. 6,412,246
U.S. 5,638,658	U.S. 5,934,866	U.S. 6,418,601
U.S. 5,640,832	U.S. 5,947,460	U.S. 6,539,615
U.S. 5,655,399	U.S. 5,987,828	U.S. 6,666,367
U.S. 5,678,395	U.S. 5,996,303	U.S. 6,702,269
U.S. 5,702,095	U.S. 6,048,165	U.S. 6,758,022
U.S. 5,707,204	U.S. 6,112,968	U.S. 6,817,392
U.S. 5,735,087	U.S. 6,134,775	U.S. 6,834,470
U.S. 5,810,341	U.S. 6,170,688	U.S. 6,907,820
U.S. 5,819,412	U.S. 6,205,637	Other patents may apply
U.S. 5,833,222	U.S. 6,212,849	

Return Goods Policy

Return goods cannot be accepted without prior authorization and are subject to a restocking charge. The Seller certifies the articles specified herein were produced in compliance with all provisions of the Fair Labor Standards Act of 1938, as amended, including Section 12.—Rev. 6/98

Reporting Errors and Recommending Improvements

To report errors or recommend improvements to this manual, please complete the Document Evaluation Form in the appendices. Mail or fax the form to:

MiTek Machinery Division
301 Fountain Lakes Industrial Drive
St. Charles, MO 63301
Attn: Engineering Manager, Fax: 636-328-9218

Notice of Change

Use this page to record Service Bulletins and Notices that you receive to keep your manual updated.

RoofTracker III™ Roof Truss Roller Press

Service Bulletin or Notice #	Dated	Title

Contents

Preliminary Pages

Legal Notice	ii
Notice of Change	iii
Contents	iv

Safety (English)

Safety Indicators: Signal Words	viii
General Equipment Safety Rules	ix
Lockout/Tagout	xii
Lockout/Tagout Guidelines	xii
Electrical Lockout/Tagout Procedures	xiv
Pneumatic System Lockout/Tagout Procedure	xvii
Troubleshooting With an Energized Machine	xvii
Safety Tests	xviii
Preparing for the Safety Test	xviii
Inspecting the Gantry Head	xix
Testing the Safety Controller	xx
Testing the Laser Scanners	xxi
Restricted Zone	xxiii
Know the Restricted Zone	xxiii
Marking the Restricted Zone	xxiv
Safety Symbol Definitions	xxv
Declarations of Conformity	xxxiii
Gantry Standards	xxxiii
E-Stop Pushbutton Standards	xxxiii
Safety Controller Standards	xxxiii
Laser Scanner Standards	xxxiv

Seguridad (Español)

Indicadores de seguridad: Palabras de aviso	xxxvi
Reglas de seguridad para el equipo de general	xxxvii
Bloqueo/Etiquetado	xl
Pautas de bloqueo/etiquetado	xl
Procedimientos de bloqueo/etiquetado eléctricos	xlii
Procedimiento de bloqueo/etiquetado del sistema neumático	xliv
Solución de problemas con una máquina energizada ..	xlvi
Pruebas de seguridad	xlvii
Preparativos para la prueba de seguridad	xlvii
Zona restringida	liv
Conocer la zona restringida	liv
Marcar la zona restringida	lv
Información adicional	lv

Introduction

Chapter 1

Introduction to the Manual	1
Purpose and Scope of This Equipment Manual	1
Navigation	2
Additional Resources	3
Web Site	3

Contents

Contacting Us	3
General Information	Chapter 2
Introduction	4
Introduction to the Equipment	5
Purpose of the Equipment	5
Overview of the Equipment	5
Extent of Manual Coverage for This Equipment	5
Main Components and Optional Equipment	8
Platform Options	8
Operating Options	9
General Specifications	9
Truss Terminology	11
Installation	Chapter 3
Responsibilities During Installation	13
Responsibilities Before Moving or Selling	13
Marking Restricted Zone	14
Marking Area On Your Own	14
Installing MiTek Restricted Zone Tape	14
Startup	Chapter 4
Checking Motor Rotation	15
Setting Pneumatic Pressure for Gantry Lifter	15
Safety Tests	16
Operation	Chapter 5
Before You Begin	17
Understanding This Chapter	17
Operating Notes	17
Stopping the Machine	18
Stopping During Normal Operation	18
Stopping for Emergencies or for Shutdown	18
Indicators	20
Beacon	20
Horn	20
Safety Controller Indicator Lights	20
Operator Control Interface Mechanisms	21
Getting Familiar with Operation	21
Operating Procedure	23
Operating Under Normal Conditions	23
Restarting Operation	25
VFD and Brakes	26
Safety Controller	26
Maintenance	Chapter 6
Safety Test	28
Lubrication	28
Brake Motor and Gearbox	29

Contents

Adding and Changing Oil	29
Using the Manual Brake Lever	30
Replacing the Gearbox and Motor	30
Replacing a Brake Pad	37
Maintaining the Air Gap	38
Drive Wheels and Idler Wheels	40
Lubricating	40
Replacing an Idler Wheel or Idler Wheel Block	41
Replacing a Drive Wheel or Drive Wheel Block	43
Guide Wheels	52
Lubricating	52
Replacing Guide Wheels	52
Pressure Wheels	55
Lubricating	55
Replacing Pressure Wheels	55
Take-Up Bearing	56
Lubricating	56
Adjusting	56
Chains	56
Lubricating the Chains	56
Adjusting Chain Tension	57
Replacing a Chain	59
Adjusting the Roller Height	60
Joystick	61
Safety Controller	62
Inspecting the Safety Controller	62
Safety Controller Operating States	63
VFD and Encoder	64
Broken Chain or Faulty Encoder	64
Managing Voltage Drops	64
Laser Scanner	65
Maintaining the Laser Scanner	65
Laser Scanner Components	67
Operating States of Laser Scanner	68
Scanning Regions and Scanner Limitations	70
Replacing the Scan Window	73
Indicator Lights and Sounding Device	74
Beacon	74
Horn	74
Graphics	75
General Graphics	75
Drive System and Wheels	76
Lubrication Graphics	78
Troubleshooting	
Appendix A	80
Navigating the Troubleshooting Appendix	80
Safety Notes for Troubleshooting	81

Contents

General Troubleshooting Safety Tips	81
Electrical Troubleshooting Safety Tips	82
Getting Started With Troubleshooting	83
Tools Needed	83
The First Steps	83
Electrical and Perimeter Guarding Troubleshooting	87
Safety Controller Diagnostics and Troubleshooting	90
Safety Controller Diagnostics	90
Safety Controller Error Names and Solutions	93
Laser Scanner Diagnostic Codes	97
Parts List	
Appendix B	99
Navigating the Parts List Appendix	99
Finding the Part Number	99
Safety Notes for Replacing Parts	100
Part Numbers	101
Mechanical Part Numbers	101
Electrical Part Numbers	101
Documentation Part Numbers	102
Guards Part Numbers	102
Labels Part Numbers	103
Maintenance Checklists	
Appendix C	104
Navigating the Maintenance Checklists	104
Safety Notes For Maintenance Checklists	105
Daily Checklist	106
Weekly Checklist	107
Monthly Checklist	108
Drawing Set	
Appendix D	109
Document Evaluation	
Appendix E	110
Glossary	113
Index	118

Safety (English)



Refiérase a la página xxxvi para español.

For safety information in Spanish, refer to *Seguridad (Español)* on page xxxvi.

Safety Indicators: Signal Words

The following signal words and colors are used throughout this manual to indicate safety hazards. Pay careful attention when you see them. The level of severity differs for each signal word and color.

Signal words are accompanied by graphics showing what personnel should or should not do. The graphics are called safety symbols and are defined on page xxv, but more specific text is provided every time a graphic is used throughout the manual. Everyone near the machine must be trained on how to read these safety indicators.

Failure to comply with the instructions accompanying each signal word may result in property damage, personal injury, or even death. Personnel must follow all safety procedures and practices to ensure the safest possible operation of this equipment. However, at no time is this document a substitute for common sense. Personnel must ensure that the work environment is safe and free of distractions.

DANGER

Indicates an imminently hazardous situation which, if not avoided, is likely to result in death or serious injury.

WARNING

Indicates a potentially hazardous situation which, if not avoided, may result in death or serious injury.

CAUTION

When CAUTION is used **with** the safety alert symbol (yellow triangle), it indicates a potentially hazardous situation which, if not avoided, may result in minor or moderate injury.

When CAUTION is used **without** the safety alert symbol, it indicates a potentially hazardous situation which may result in equipment damage.

NOTICE

Calls attention to information that is significant to understanding the operation at hand.

ENVIRONMENTAL

Applies to conditions that may affect the environment but do not have an immediate, direct effect on personnel or equipment.

General Equipment Safety Rules



Because it is impossible to anticipate every circumstance that might involve a hazard, the safety information provided in this equipment manual and on the machine is not all-inclusive. If this machine is operated or serviced using a procedure not specifically recommended by the manufacturer, the procedure shall be approved by a professional engineer to ensure it will not render the equipment unsafe. Use extreme caution and common sense at all times!

Know Your Equipment

- Read this manual completely before using or maintaining the equipment. Do not operate this machine unless you have a thorough knowledge of the controls, safety devices, emergency stops, and operating procedures outlined in this manual.
- Read and follow all safety notes. Failure to comply with these instructions may result in economic loss, property damage, and/or personal injury including death.
- Refer to the lockout/tagout guidelines on the following pages to safely perform maintenance and troubleshooting of this equipment.
- Observe and obey all safety labels. Replace worn labels immediately.
- Use this equipment solely for the purpose described in this manual.
- Only qualified personnel should attempt to operate or perform maintenance on this equipment. “Qualified personnel” is defined as:

...a person or persons who, by possession of a recognized degree or certificate of professional training, or who, by extensive knowledge, training, or experience, has successfully demonstrated the ability to solve problems relating to the subject matter and work—ANSI B30.2-1983

...one who has skills and knowledge related to the construction and operation of the electrical equipment and installations and has received safety training on the hazards involved—NEC 2002 Handbook

Personal Safety

- Always wear safety glasses and hearing protection in an industrial environment.
- Utilize a filtering face piece (dust mask) when working near sawdust.
- Wear proper clothing and appropriate personal protective equipment (e.g., safety glasses and hearing protection.) Do not wear loose clothing or jewelry. Confine long hair by tying it back.
- Use caution when lifting heavy parts or material.

Installing the Equipment

- Follow all installation instructions completely.
- This equipment is not for use in a residential area.



Lockout/Tagout

- Before performing maintenance on the pneumatic systems, bleed the lines to eliminate pressure.
- Lockout/tagout all energized systems before performing maintenance on them. Refer to the *Lockout/Tagout Guidelines* section on page xii.

Keeping a Safe Environment

- Keep children away. All visitors should be kept a safe distance from the work area. Hazards may not be apparent to individuals unfamiliar with the machine.
- Keep work areas well lit.
- Keep the work area clean and free of any trip or slip hazards.
- Do not use the equipment in damp or wet locations or expose it to rain or snow.
- Minimize dust clouds and protect your equipment by cleaning dust in this manner:
 - Vacuum dust prior to blowing with air



Never use compressed air inside the electrical enclosures! It may force contaminants into the electrical connections.

Use a vacuum to remove dust from electrical enclosures. Canned air is acceptable after vacuuming.

- Shut down electrical power and sources of ignition
- If using compressed air, it should be a low compression (no more than 15 psi)
- Powered cleaning equipment such as vacuums must be consistent with local governmental codes for use in dusty conditions.

Operating and Maintaining the Equipment

- Ensure that all people, tools, and foreign objects are clear of the restricted zones before operating this equipment. The restricted zones are shown on page xxiii.
- Perform safety tests to ensure all E-stops are working properly before operating the equipment at the initial startup, after performing any maintenance, and in accordance with the maintenance schedule.
- In case of machine malfunction, stop the machine immediately using an E-stop and report the malfunction to a supervisor.

- Never leave the machine running unattended. Turn the power off! Do not leave the machine until all parts have come to a complete stop and all electrical power has been shut off.
- Check for worn or damaged parts regularly. Repair or replace them immediately.
- Keep the pneumatic and electrical systems in good working order at all times. Repair leaks and loose connections immediately. Never exceed the recommended pressure or electrical power.
- Check that all safety devices are in working order before each shift starts. All protective guards and safety devices must be in place before and during use of the machine. Never disconnect or bypass any safety device or electrical interlock.
- Only qualified maintenance personnel shall remove or install safety devices.
- Periodically inspect the quality of the finished product.

Electrical Safety

- Do not use any liquids in the interior of electrical cabinets.
- When using solvents on and around the machine, remove power to the machine to eliminate the chance of sparking, resulting in explosion or fire. Wear a respirator approved for use with solvents. Wear protective clothing, gloves, and safety glasses.

Lockout/Tagout

Lockout/Tagout Guidelines

All lockout/tagout guidelines must be met according to OSHA 29 CFR 1910.147. A specific procedure should be included in your company's energy control program. This manual is not intended to replace your company's de-energizing or lockout/tagout procedure required by OSHA, but merely to provide general guidance.

The term "lockout," as used in this manual, means placing a lockout device on any and all energy sources to ensure that the energy isolating device and the equipment being controlled cannot be re-energized or operated until the lockout device is removed. Figure SAFETY-1 on page xiii shows where the electrical disconnect switch is located for this machine.



Energy sources include electrical, mechanical, hydraulic, pneumatic, chemical, thermal, or other energy.

- In the case of electrical energy sources, the main power and control power to the machinery must be turned off and physically locked in the Off position.
- A lockout device is usually a keyed padlock.
- If more than one person is working in a restricted zone, use a group lockout device that will allow each person to use a lock that can be removed only by the person performing the maintenance.

"Tagout" means that a prominent warning is securely fastened to an energy-isolating device to indicate that the equipment shall not be operated.

Whenever you see the symbol at left, lockout/tagout!



Figure SAFETY-1: Disconnect Switch Location

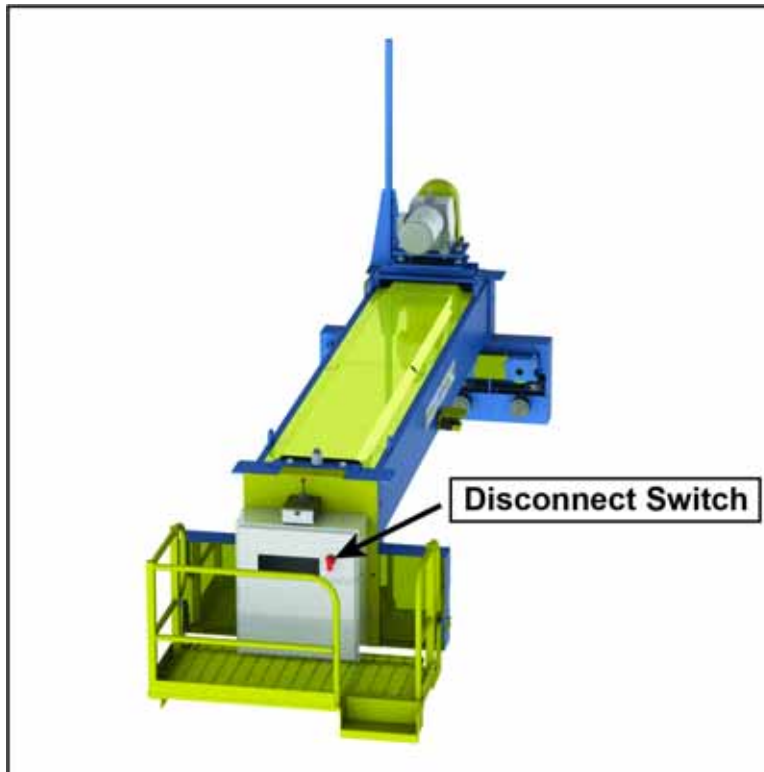

Switch location is the same regardless of platform location

Electrical Lockout/Tagout Procedures



When Working on a Machine Outside the Machine's Main Electrical Enclosure



If working on the electrical transmission line to the machine, follow the procedure on page xvi.

Before performing maintenance on any machine with electrical power, lockout/tagout the machine properly. When working on a machine outside of the machine's main electrical enclosure, not including work on the electrical transmission line to the machine, follow your company's approved lockout/tagout procedures which should include, but are not limited to the steps here.

1. Engage an E-stop on the machine.
2. Turn the disconnect switch handle to the Off position. See Figure SAFETY-2.



 WARNING	
	<p>ELECTROCUTION HAZARD.</p> <p>When the disconnect switch is off, there is still live power within the disconnect switch's enclosure. Always turn off power at the building's power source to the equipment before opening this electrical enclosure!</p>

Figure SAFETY-2: Disconnect Switch



3. Attach a lock and tag that meet OSHA requirements for lockout/tagout.
4. Restrain or de-energize all pneumatic components and other parts that could have live or stored power.

Figure SAFETY-3: Sample of a Lockout/Tagout Mechanism on an Electrical Enclosure





When Working on a Machine Inside the Machine's Main Electrical Enclosure or in the Electrical Transmission Line to the Machine

Before opening the main electrical enclosure, or attempting to repair or replace an electrical transmission line to the machine, lockout/tagout the machine properly. Follow your company's approved lockout/tagout procedures which should include, but are not limited to the steps here.

1. Engage an E-stop on the machine.
2. Shut the power to the machine off at the machine's power source, which is usually an electrical service entry panel on the facility wall. One example of a locked-out electrical service entry panel is shown in Figure SAFETY-4.
3. Attach a lock and tag that meets OSHA requirements for lockout/tagout.
4. Open the door to the enclosure in which you need access, and using a multimeter, verify that the power is off.

Figure SAFETY-4: Sample of a Lockout/Tagout Mechanism on a Power Source Panel



Pneumatic System Lockout/Tagout Procedure

When Lockout/Tagout is Not Required

End-eject systems for the *RoofTracker III* have a gantry lifter. The gantry lifter includes pneumatic components. If working on components other than the pneumatic system, but that requires you to be near the vicinity of movable pneumatic components, you must, at a minimum, physically restrain the pneumatic components from moving. If this is not possible, lockout/tagout the entire pneumatic system.



When Lockout/Tagout is Required

Before attempting repair or maintenance on a pneumatic line or component, lockout/tagout the machine properly. Follow your company's approved lockout/tagout procedures.

Troubleshooting With an Energized Machine

Only a qualified electrician, using the personal protective equipment and following the procedures recommended in NFPA 70E, should ever attempt service or repair of or near an energized area or component of the machine.

Whenever maintenance is performed while the equipment is electrically energized, there is a potential electric arc flash hazard. Refer to NFPA 70E for the personal protective equipment required when working with electrically energized components. Pneumatic components may move unexpectedly if not de-energized. Physically restrain any components capable of movement when working on or near those components.

Safety Tests

This test procedure **MUST** be performed by qualified personnel at startup and after ANY maintenance, adjustment, or modification. This test procedure **MUST** also be performed before each shift starts. Testing ensures that the safety system and machine control system work together to properly stop the machine.

Preparing for the Safety Test

Locating the Operator Control Station

The operator control station for the gantry head is located on the same side as the operator platform. The operator control station includes a joystick, a Reset, an E-stop, and the Right Ready and Left Ready lights. See Figure SAFETY-5.

You should be familiar with the operator control station before performing the safety test.

Figure SAFETY-5: Controls

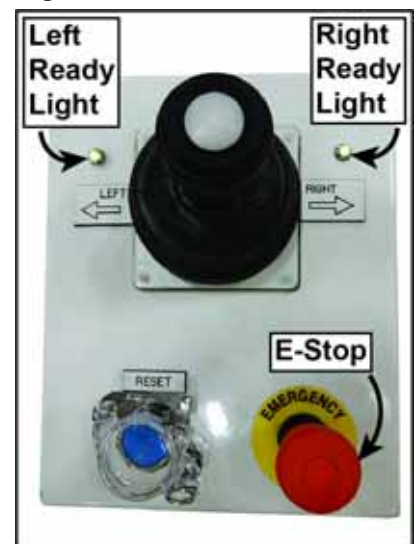



Creating a Wooden T

For the safety test, permanently fasten two pieces of wood together to form a T. The T should be a minimum of 20" tall. The T should be able to stand upside down on its own. See Figure SAFETY-6.

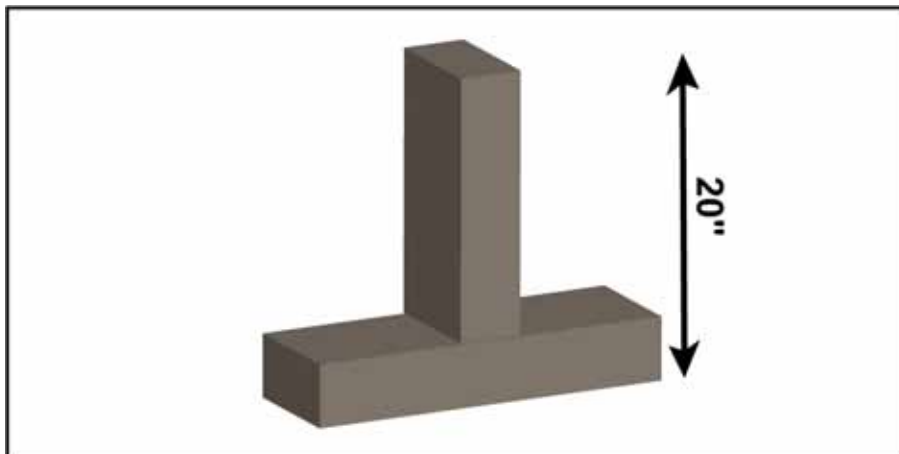
Figure SAFETY-6: Wooden T





Inspecting the Gantry Head

	 DANGER
	<p>If the gantry head fails any part of this safety test, fix the problem before proceeding to the next step.</p> <p>Operating a gantry head that has failed any part of the safety test may result in serious injury or death.</p>

1. Lockout/tagout on the electrical service entry panel. See page xvi for an example of an electrical service entry panel.
2. Make sure that all safety labels are legible.
3. Check for signs of external damage to the laser scanner, the guards on the machine, the electrical cables, and the wiring.
4. Clean dust and fingerprints from the scanner window using a soft, lint-free cloth and a common glass / plastic cleaner. Do NOT use thinner, benzene, or acetone for cleaning because it could damage the window. See page 65 for the location of the scanner window on the scanner.
5. Check the chain tension to make sure that the tension is correct. See page 57 for detailed instructions.
6. Check the conditions of the pressure, drive, idler, and guide wheels to make sure they are intact. See page 77 for a graphic with the location of the wheels.
7. Check the track tubes where the wheels meet the tables to make sure they are free of debris.

Testing the Safety Controller

1. Remove the lock and tag. Restore power to the gantry head.



 DANGER	
	<p>Take precautions to ensure only the person performing the test will be near the machine during this test. Power must remain on to perform the test.</p>

2. Verify that the safety controller (in the main enclosure) doesn't have any faults (ERR/ALM red light, blinking or solid). See Figure SAFETY-7.

Figure SAFETY-7: Safety Controller ERR/ALM Light Location



3. Verify that the machine braking system is working properly by using the following steps.

 DANGER	
	<p>Never stand directly in front of the gantry head!</p> <p>Operators must ensure no other personnel are in the safety zone or restricted zone when performing these tests!</p> <p>If the gantry head fails to stop when expected, serious injury or death may occur.</p>

- a) Start the gantry head moving to the right (see step 2 on page xxi) and run until it is at full speed.
- b) Press an E-stop and ensure the gantry head stops. The gantry head should not skid during the stop. Skidding may indicate a problem with the tension of the chain or condition of the wheels.
- c) Disengage the E-stop. Press the Reset button.
- d) Repeat with the gantry head moving to the left.

Testing the Laser Scanners

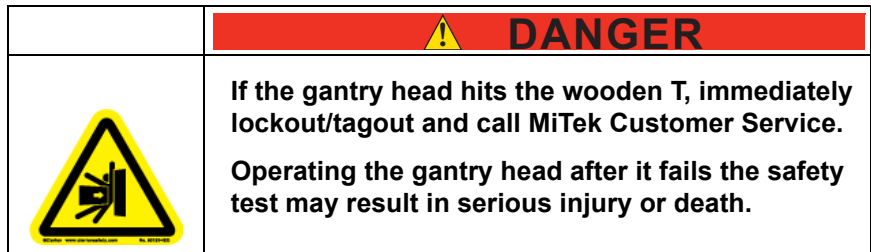

1. Place the wooden T on the table at least 10 feet from one scanner. It should be placed with one end sticking in the air like the wooden T in Figure SAFETY-6 on page xviii.
2. Move the gantry head by using the following steps.
 - a) Disengage the E-stop. Press the Reset button.
 - b) Check the Left Ready and Right Ready lights on either side of the joystick. Both should be illuminated in green.
 - c) Press the white button on the joystick and move the joystick toward the wooden T. Keep moving the joystick toward the wooden T.
3. Check to make sure the following events happen when the gantry head approaches the wooden T.
 - a) The gantry head should slow down when the wooden T enters the warning zone. See page 71 and page 72 for graphics of the warning zone.
 - b) It should initiate an emergency stop when the wooden T reaches the safety zone. See page 71 and page 72 for graphics of the safety zone.



- c) It should stop without skidding and without hitting the wooden T.
 - d) The beacon should turn red.
 - e) The Ready light nearest to the wooden T should not be illuminated.
4. Check the operator control station to make sure the Ready light farthest from the wooden T is illuminated.

5. Hold the Reset button. Press the white button on the joystick and move the joystick away from the wooden T. After an E-stop, the gantry head should move away from the wooden T but not toward it.
The Reset button can be released after both the Left Ready and Right Ready lights are illuminated.
6. Repeat step 1 through step 5 with the scanner on the other side of the gantry head.

Restricted Zone

	 DANGER
	<p>Stay out of the restricted zone when equipment is in use. Serious injury or death may result if personnel are in the restricted zone.</p> <p>Always look for personnel in the restricted zone before operating equipment.</p>

Know the Restricted Zone

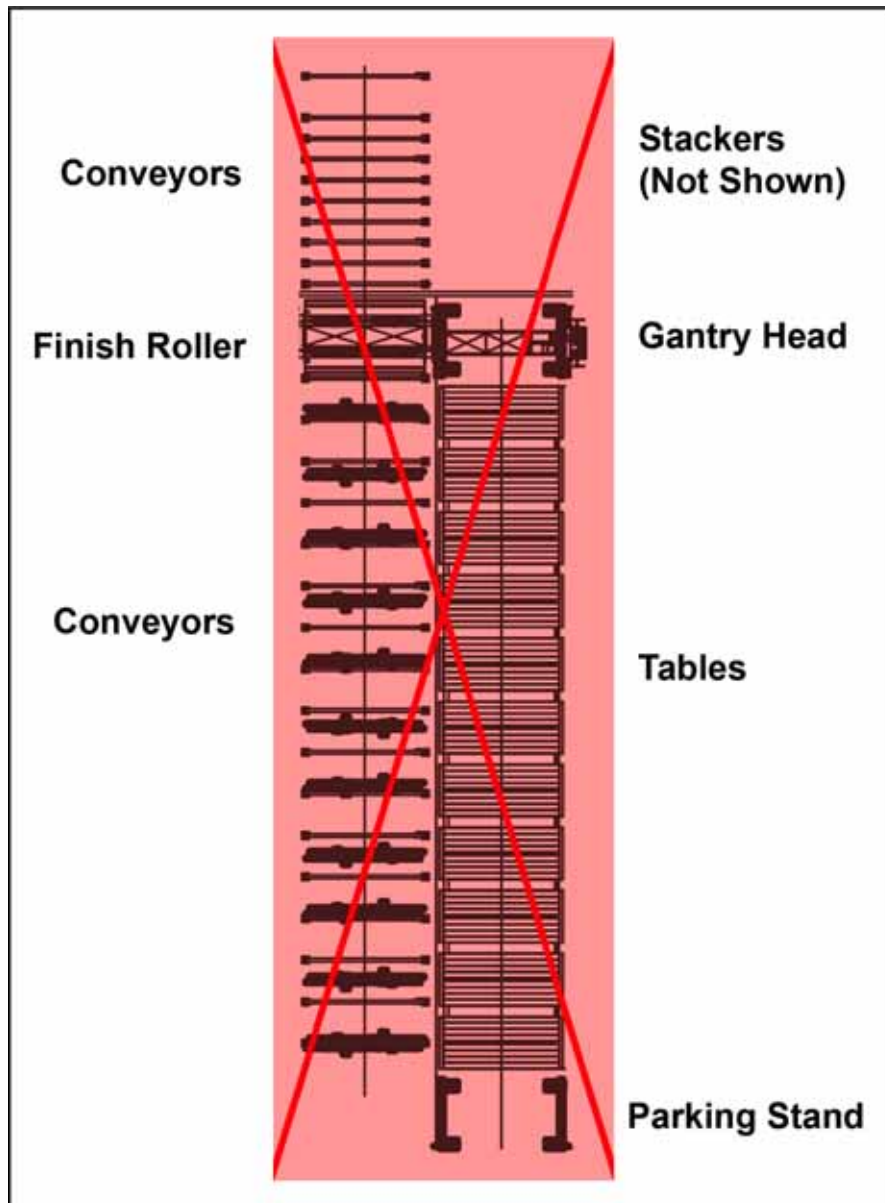

Marking the Restricted Zone

The restricted zone must be marked before operating the *RoofTracker III* so that everyone near the equipment can clearly see the area where danger may exist. See page 14 for more details regarding installation.

Safety Symbol Definitions

The safety symbols shown in this section can be found throughout the manual to indicate hazards that are related to this equipment. All personnel expected to operate or maintain this equipment should become familiar with these safety symbols and what they mean.



This is the Electrical Hazard Symbol. It indicates that there are dangerous high voltages present inside the enclosure of this product and/or that a power source is present. To reduce the risk of fire or electric shock, do not attempt to open the enclosure or gain access to areas where you are not instructed to do so. Refer servicing to qualified service personnel only.

This product should be operated only from the type of source indicated on the manufacturer's identification label. Installation should be in compliance with applicable sections of the national electric code. Consult your local building code before installing.



This is the user caution symbol. It indicates a condition where damage to the equipment resulting in injury to the operator could occur if operational procedures are not followed. To reduce the risk of damage or injury, refer to accompanying documents, follow all steps or procedures as instructed.



Hot surface! Surface temperature can exceed greater than 158°F (70°C) during normal operation. Do not touch.



Operation of this equipment may result in flying debris and excessive noise. To reduce the risk of injury, wear only approved PPE.



Crush hazard! Keep hands clear.





Keep feet away from moving parts.



Keep hands away from moving parts.



Equipment produces loud noise in excess of 100 DBA during operation. Use appropriate hearing protection when in vicinity of this equipment.



Use sling equipment rated for 10,000 lbs (4,400 kg) when lifting this equipment.



Crush hazard from above



Lethal materials



Slip hazard! Use of approved footwear is required.



Trip hazard! Pay attention when walking in this area.



Keep hands and body clear.





The operation of this equipment requires the use of PPE.
Do not operate without wearing required protective clothing.





Refer to manual- After installation, read the user's guide carefully before operating. Follow all operating and other instructions carefully.



Circuits are live: lockout/tagout the upstream disconnecting means prior to opening for service.



Lockout in a de-energized state



Lift point: in order to reduce the likelihood of damage to the equipment, use only the lift points indicated in the manual.



Open switch before adjusting equipment.



Consult material safety data sheet.



Read all safety warnings and instructions before proceeding.



Unplug equipment before servicing.



No open flames in this area



No smoking in this area



Hazardous moving parts are located behind this access panel. Do not operate this equipment without all guards and covers in place.



Do not place containers with liquids such as coffee, water, sodas, etc. on this unit.

Do not operate this equipment in a wet environment.



Do not expose to water



No lift point. Do not lift this device with a hook/crane assembly. Damage to the equipment will be incurred. Refer to the installation instructions.



Do not step or stand upon this equipment. Risk of serious injury may result.

No step! Do not step or stand at this location.



Use of fork lift equipment when moving this equipment will result in serious equipment damage. Refer to installation procedures.



Do not use non-approved lubricants in this machine.



Unauthorized persons are not allowed beyond this point.



Do not operate without guards and covers in place



oil drop

Declarations of Conformity

Gantry Standards

All safety devices on this equipment are compliant with United States safety regulations and conform to current NEC, NFPA79, OSHA 21 CFR 1910, and UL regulations.

Electrical components also adhere to international safety codes including, but not limited to, IEC 6149, EN 954 and/or ISO 13849.

E-Stop Pushbutton Standards

According to the *Rockwell Automation™* document with document control number LCC-0100-F-EN:

The *Allen-Bradley™* 800F Series, identified as IEC 22.5 mm pushbuttons and enclosure, is in conformity with the essential requirements of the following EC directives:

- 2006/95/EC
- 2004/108/EC
- 98/37/EC and 2006/42/EC

The standards and/or technical specifications below have been applied:

- EN 60947-1:2007
- EN 60947-5-1:2004
- EN 60947-5-5:1997 + A1:2005
- EN ISO 13850:2008

Year of CE Marking (Low Voltage Directive): 2003

Safety Controller Standards

The safety controller, as a stand-alone unit, conforms to the following standards per *OMRON™* Cat No. Z922-E1-01, page xxvi-xxvii (as of 12 October 2011):

- EMC Directive (2004/108/EC)
- Machinery Directive (2006/42/EC)
- EN ISO 13849-1:2008 and IEC/EN 62061 SIL CL3
- EN 61000-6-4

Laser Scanner Standards

The laser scanner, model OS32C series, conforms to the following standards per *OMRON STI* Manual No. Z296-E1-04, page i (as of 12 October 2011):

1. This product is electro-sensitive protective equipment (ESPE) in accordance with European Union (EU) Machinery Directive Index Annex IV, B, Safety Components, Item 1.
2. This product complies with the following legislation and standards:
 - a) EU legislation
 - Machinery Directive 2006/42/EC
 - EMC Directive 2004/108/EC
 - Low Voltage Directive (2006/95/EC)
 - RoHS Directive (2002/95/EC)
 - b) European & International Standards
 - EN 61496-1:2004 + A1:2008 (Type 3 ESPE)
 - EN 62061:2005
 - EN 50178:1999
 - EN ISO 13849-1:2008 + AC:2009
 - IEC 61496-3:2008 (Type 3 AOPDDR)
 - IEC 61508, Parts 1-7:1998/2000 (SIL-2)
 - EN 60204-1:2006
 - c) North American Standards: per UL File E241445, US and C-UL approvals (CNN: NIPM/NIPM7).
 - ANSI/UL 508 (Industrial Control Equipment)
 - ANSI B11.19:2003
 - ANSI/RIA R15.06:1999
 - NFPA 79:2007
 - Code of Federal Regulations CFR29:1990
 - IEC 61496-1 (Type 3 ESPE)
 - IEC 61496-3 (Type 3 AOPDDR)
 - UL 1998 (Software in Programmable Components)
 - IEC 61508 (Functional Safety of Electrical/Electronic/Programmable Electronic Safety-Related Systems)

- IEC 61508-3 (Functional Safety of Electrical/Electronic/Programmable Electronic Safety-Related Systems - Part 3: Software Requirements)
 - CAN/CSA-C22.2 No. 14 (Industrial Control Equipment)
 - CAN/CSA-C22.2 No. 0.8 (Safety Functions Incorporating Electronic Technology)
- d) JIS standards JIS B 9704-1:2006, JIS B 9704-3:2004 (Type3 ESPE)
3. This product received the following approvals from TÜV Rheinland of the EU.
- EC Type-Examination in accordance with the EU Machinery Directive, Type 3 ESPE (IEC61496-1), Type 3 AOPDDR (IEC61496-3)

Seguridad (Español)

Indicadores de seguridad: Palabras de aviso

Las siguientes palabras y colores de aviso se utilizan a lo largo de este documento para indicar riesgos de seguridad. Preste suma atención cuando los vea. El nivel de gravedad es diferente por cada palabra o color de aviso.

Las palabras de aviso van acompañadas por gráficos que muestran al personal lo que deben y no deben hacer. Los gráficos se llaman símbolos de seguridad y se definen en la página xxv, pero se proporciona un texto más específico cada vez que se utiliza un gráfico por todo el manual. Todas las personas que estén cerca de una máquina tienen que ser capacitadas en cómo leer estos indicadores de seguridad.

No cumplir las instrucciones que acompañan cada palabra de aviso puede producir daños a la propiedad, lesiones personales e incluso la muerte. El personal debe seguir todos los procedimientos y prácticas de seguridad establecidos para asegurar el uso más seguro posible de este equipo. No obstante, en ningún caso este documento reemplaza el sentido común. El personal debe asegurarse de que el entorno de trabajo sea seguro y esté libre de distracciones.

PELIGRO Indica una situación potencialmente peligrosa que, si no se evita, podría producir la muerte o lesiones graves.
ADVERTENCIA Indica una situación potencialmente peligrosa que, si no se evita, podría producir la muerte o lesiones graves.
PRECAUCIÓN Indica una situación potencialmente peligrosa que, si no se evita, puede producir lesiones menores o moderadas.
AVISO Llama la atención a información importante para entender la operación que se desea realizar.
AMBIENTAL Se aplica a condiciones que pueden afectar el entorno pero que no tienen un efecto inmediato o directo sobre el personal o el equipo.

Reglas de seguridad para el equipo de general



Debido a la imposibilidad de anticipar todas las circunstancias que podrían constituir un riesgo, la información de seguridad suministrada en este manual del equipo y sobre la máquina no es exhaustiva. Si se utiliza o realiza el mantenimiento de esta máquina utilizando un procedimiento no recomendado específicamente por el fabricante, el procedimiento deberá ser aprobado por un ingeniero profesional para asegurarse de que no afecte la seguridad del equipo. ¡Manéjese siempre con suma precaución y sentido común!

Conozca su equipo

- Lea este manual en su totalidad antes de utilizar o mantener el equipo. No utilice esta máquina a menos que esté perfectamente familiarizado con los controles, los dispositivos de seguridad, los frenos de emergencia y los procedimientos operativos que se describen en este manual.
- Lea y siga todas las notas de seguridad. El no cumplimiento de estas instrucciones podría producir pérdidas económicas, daños a la propiedad y lesiones personales, incluida la muerte.
- Refiérase a las pautas de bloqueo/etiquetado proporcionadas en las siguientes páginas para realizar el mantenimiento y solucionar problemas de este equipo en forma segura.
- Observe y cumpla con todas las etiquetas de seguridad. Cambie las etiquetas gastadas inmediatamente.
- Utilice este equipo únicamente para el propósito que se describe en este manual.
- Sólo personal calificado debe intentar utilizar o realizar el mantenimiento de este equipo. Por "personal calificado" se entiende:

*...una persona o personas que, por el hecho de poseer un título o certificado de capacitación profesional reconocido o que, por sus amplios conocimientos o experiencia, han demostrado con éxito estar capacitados para resolver problemas relacionados con el tema y el trabajo en cuestión
—ANSI B30.2-1983*

...una persona que posee habilidades y conocimientos relacionados con la construcción y uso de equipos e instalaciones eléctricas y que ha recibido capacitación en seguridad sobre los riesgos posibles—NEC 2002 Handbook

Seguridad personal

- Use siempre lentes de seguridad y protección auditiva en un entorno industrial.
- Utilice una máscara protectora cuando trabaje cerca de aserrín.
- Utilice ropa adecuada y equipo de protección personal apropiado (por ejemplo, lentes de seguridad y protección auditiva.) No use ropa suelta ni joyas. Si tiene el cabello largo, áteselo para atrás.
- Proceda con precaución cuando levante piezas o materiales pesados.

Instalación del equipo

- Siga las instrucciones de instalación al pie de la letra.
- No utilizar este equipo en zonas residenciales.



Procedimientos de Bloqueo/Etiquetado

- Antes de realizar el mantenimiento de los sistemas neumáticos o hidráulicos, purgue las líneas para eliminar la presión.
- Bloquee y etiquete todos los sistemas energizados antes de realizar tareas de mantenimiento en ellos. Refiérase a la sección *Pautas de bloqueo/etiquetado* en la página xl.

Cómo mantener un entorno seguro

- Mantenga alejados a los niños. Todos los visitantes deben mantenerse a una distancia segura del área de trabajo. Los riesgos pueden no ser evidentes a las personas no familiarizadas con la máquina.
- Mantenga las áreas de trabajo bien iluminadas.
- Mantenga el área de trabajo limpia y libre de cualquier riesgo de tropiezo o resbalamiento.
- No utilice el equipo en lugares húmedos o mojados y no lo exponga a la lluvia o a la nieve.
- Minimice las nubes de polvo y proteja su equipo quitando el polvo de la siguiente manera:
 - Aspire el polvo antes de soplarlo con aire
 - Apague la alimentación eléctrica y todas las fuentes de ignición
 - Si usa aire comprimido, debe ser a compresión baja (no más de 15 psi)
 - El equipo eléctrico de limpieza como las aspiradoras debe cumplir con los códigos del gobierno local para uso en condiciones polvorientas.

Uso y mantenimiento del equipo

- Asegúrese de que no haya personas, herramientas y objetos extraños en las zonas restringidas antes de utilizar este equipo. Las zonas restringidas se indican en la página xxiii.
- Realice pruebas de seguridad para verificar que todos los frenos de emergencia funcionen adecuadamente antes de utilizar el equipo por primera vez, después de realizar cualquier tarea de mantenimiento y según la frecuencia de mantenimiento establecida.
- En caso de que la máquina no funcione correctamente, deténgala inmediatamente utilizando un freno de emergencia e informe el problema a un supervisor.

- No deje nunca la máquina encendida si no está junto a ella. ¡Apáguela! No la abandone hasta que todas las piezas se detengan completamente y hasta que se haya apagado la alimentación eléctrica.
- Verifique periódicamente que no haya piezas gastadas o dañadas. Repárelas o cámbielas inmediatamente.
- Mantenga los sistemas hidráulicos, neumáticos y eléctricos en buen funcionamiento en todo momento. Repare las fugas y las conexiones sueltas inmediatamente. No exceda nunca la presión ni potencia eléctrica recomendadas.
- Verifique que todos los dispositivos de seguridad estén en buen funcionamiento antes de comenzar de cada turno. Todos los dispositivos protectores y de seguridad deben estar en su lugar antes y durante el uso de la máquina. No desconecte ni evite nunca ningún dispositivo de seguridad ni interbloqueo eléctrico.
- Solo el personal de mantenimiento calificado puede quitar o instalar los dispositivos de seguridad.
- Inspeccione periódicamente la calidad del producto terminado.

Seguridad eléctrica

- No utilice líquidos en el interior de los gabinetes eléctricos.
- Cuando utilice disolventes sobre o alrededor de la máquina, desconecte la alimentación para eliminar las probabilidades de chispas, que pueden producir una explosión o incendio. Use un respirador aprobado para el uso con disolventes. Use ropa protectora, guantes y lentes de seguridad.

Bloqueo/Etiquetado

Pautas de bloqueo/etiquetado

Deben cumplir con todas las pautas de bloqueo/etiquetado conforme a la norma OSHA 29 CFR 1910.147. El programa de control de energía de la compañía debe incluir un procedimiento específico. El objetivo de este manual no es reemplazar el procedimiento de desenergización o bloqueo/etiquetado requerido por la OSHA, sino proporcionar pautas orientativas generales.

El término "bloqueo", según se utiliza en este manual, se refiere a la colocación de un dispositivo de bloqueo en las fuentes de energía para asegurar que el dispositivo aislador de energía y el equipo controlado por éste no puedan reenergizarse o utilizarse hasta que se retire dicho dispositivo.

Las fotos de la página siguiente muestran los lugares en los que se encuentran los interruptores de desconexión eléctrica de esta máquina.



- Las fuentes de energía incluyen energía eléctrica, mecánica, hidráulica, neumática, química, térmica y otras.
- En el caso de fuentes de energía eléctrica, la alimentación principal y la alimentación de control a la maquinaria deben apagarse y bloquearse físicamente en la posición "off" (apagado).
- Por lo general, como dispositivo de bloqueo se utiliza un candado con llave.
- Si hay más de una persona trabajando en una zona restringida, utilice un dispositivo de bloqueo grupal que permita a cada persona utilizar un candado que sólo pueda ser retirado por la persona que realiza el mantenimiento.

"Etiquetado" significa que debe colocarse una advertencia fácil de ver en un dispositivo aislador de energía que indique que el equipo no debe utilizarse.

Siempre que vea este símbolo, ¡Bloquee/Etiqueta!



Figura 3-1

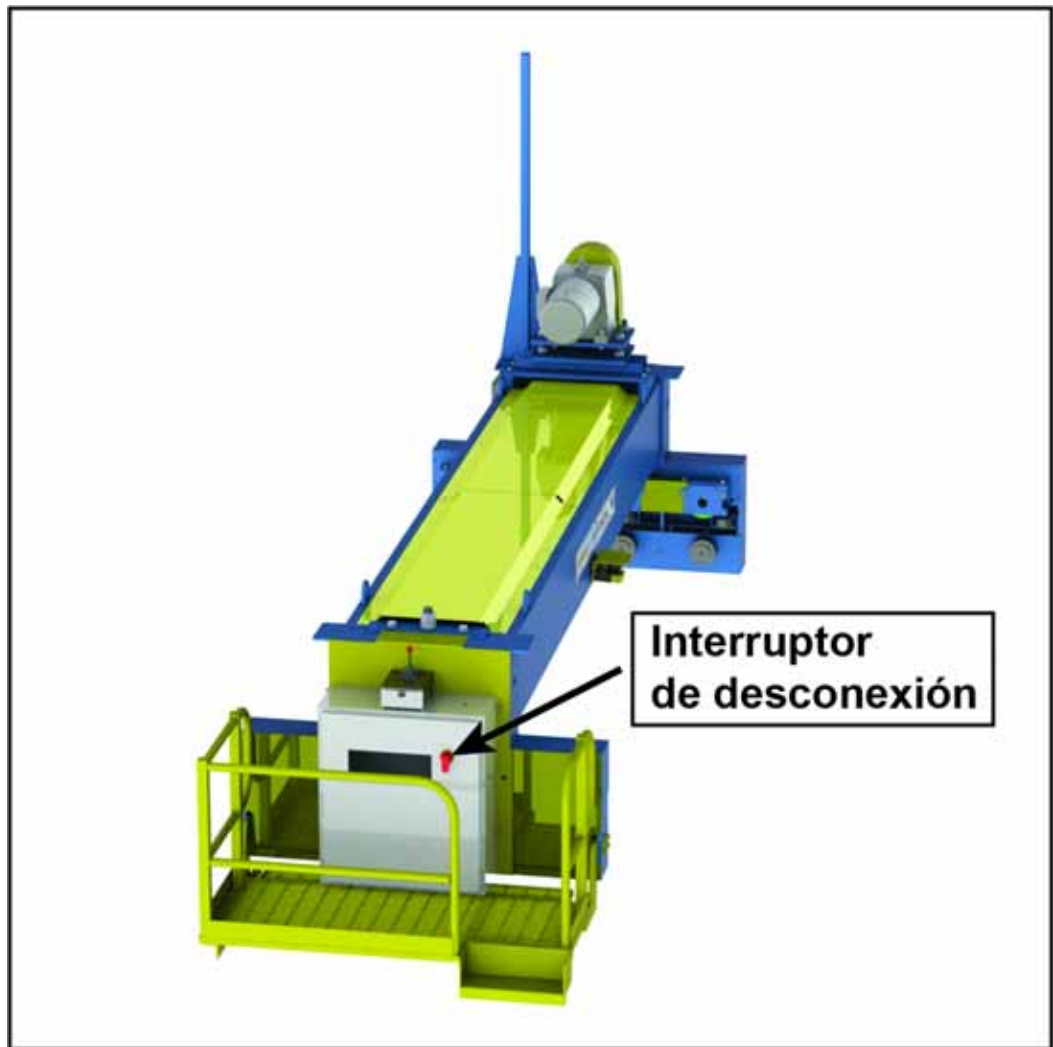

La ubicación del interruptor es la misma sin importar la ubicación de la plataforma.

Procedimientos de bloqueo/etiquetado eléctricos

Cuando trabaja en una máquina fuera del gabinete eléctrico principal de la máquina



Si trabaja en la línea de transmisión eléctrica a la máquina, siga el procedimiento de la página xliv.

Antes de realizar el mantenimiento de cualquier máquina con alimentación eléctrica, bloquee y etiquete la máquina de forma adecuada. Cuando trabaje en una máquina fuera del gabinete eléctrico principal de la máquina, salvo en el caso de trabajos en la línea de transmisión eléctrica a la máquina, siga los procedimientos de bloqueo/etiquetado aprobados por la compañía, los cuales deberían incluir, entre otros, los pasos aquí indicados.

1. Coloque un freno de emergencia sobre la máquina.
2. Coloque el mango del interruptor con fusibles en la posición "apagado/apagada."



 WARNING	
	<p>RIESGO DE ELECTROCUCIÓN.</p> <p>Cuando el interruptor con fusibles está apagado, sigue habiendo energía dentro del gabinete del interruptor. ¡Apague siempre la alimentación en la fuente de alimentación del edificio antes de abrir este gabinete eléctrico!</p>

Figure 3-2



3. Coloque un candado y una etiqueta que cumplan con los requisitos de bloqueo/etiquetado de la OSHA.
4. Trabe o desenergice todos los componente neumáticos, componentes hidráulicos y otras piezas que tengan alimentación directa o almacenada.

Figura SEGURIDAD-4





Cuando trabaje en una máquina dentro del gabinete eléctrico principal de la máquina o en la línea de transmisión eléctrica a la máquina

Antes de abrir el gabinete eléctrico principal o intentar reparar o reemplazar una línea de transmisión eléctrica a la máquina, bloquee y etiquete la máquina en forma adecuada. Siga los procedimientos de bloqueo/etiquetado aprobados por la compañía, los cuales deberían incluir, entre otros, los pasos aquí indicados.

1. Coloque un freno de emergencia sobre la máquina.
2. Apague la alimentación a la máquina en la fuente de alimentación, que, por lo general, es un panel de entrada de suministro eléctrico que se encuentra en una pared de las instalaciones. En la Figura SEGURIDAD 5 se muestra un ejemplo de panel de fuente de alimentación bloqueado.
3. Coloque un candado y una etiqueta que cumplan con los requisitos de bloqueo/etiquetado de la OSHA.
4. Abra la puerta del gabinete al que necesita acceder y usando un multímetro verifique que la alimentación esté apagada.

Figura SEGURIDAD-5



Procedimiento de bloqueo/etiquetado del sistema neumático

Cuando no se requiere bloqueo/etiquetado

Los sistemas de eyección de *RoofTracker III* cuentan con un elevador del pórtico, el cual incluye componentes neumáticos. Si trabaja con componentes que no son del sistema neumático pero que requieren su presencia en la proximidad de componentes neumáticos móviles, debe, como mínimo, trabar físicamente estos componentes para que no se muevan. Si no es posible, bloquee/etiquete todo el sistema neumático.



Cuando se requiere bloqueo/etiquetado

Antes de intentar reparar o realizar el mantenimiento de una línea o componente neumático, bloquee/etiquete la máquina en forma apropiada. Siga los procedimientos de bloqueo/etiquetado aprobados por la compañía.

Solución de problemas con una máquina energizada

Sólo un electricista calificado que utilice el equipo de protección personal y siga los procedimientos recomendados en la norma NFPA 70E debe intentar realizar tareas de reparación o mantenimiento en un área o componente energizados de la máquina o en su proximidad.

Cada vez que se realizan tareas de mantenimiento mientras el equipo está eléctricamente energizado, existe un riesgo potencial de formación de un arco eléctrico. Consulte en la norma NFPA 70E el equipo de protección personal requerido para trabajar con componentes eléctricamente energizados. Los componentes neumáticos e hidráulicos pueden moverse de manera imprevista si no se desenergizan. Trabe físicamente cualquier componente que pueda moverse cuando deba trabajar en ellos o en su proximidad.

Pruebas de seguridad

Este procedimiento de prueba DEBE ser realizado por personal calificado al momento de iniciar el sistema y después de CUALQUIER tarea de mantenimiento, ajuste o modificación. Este procedimiento de prueba también se DEBE realizar antes de cada inicio de turno. Las pruebas permiten verificar si el sistema de seguridad y el sistema de control funcionan juntos y detienen la máquina de manera adecuada.

Preparativos para la prueba de seguridad

Ubicación de la estación de control del operador

La estación de control del operador de la cabeza del pórtico se encuentra del mismo lado de la plataforma del operador. La estación incluye una palanca de mando, un botón de Restablecimiento, un botón de Paro de emergencia y las luces “Ready” (Listo) derecha e izquierda. Vea la Figura SEGURIDAD-5.

Deberá familiarizarse con la estación de control del operador antes de realizar la prueba de seguridad.

Figura SEGURIDAD-6



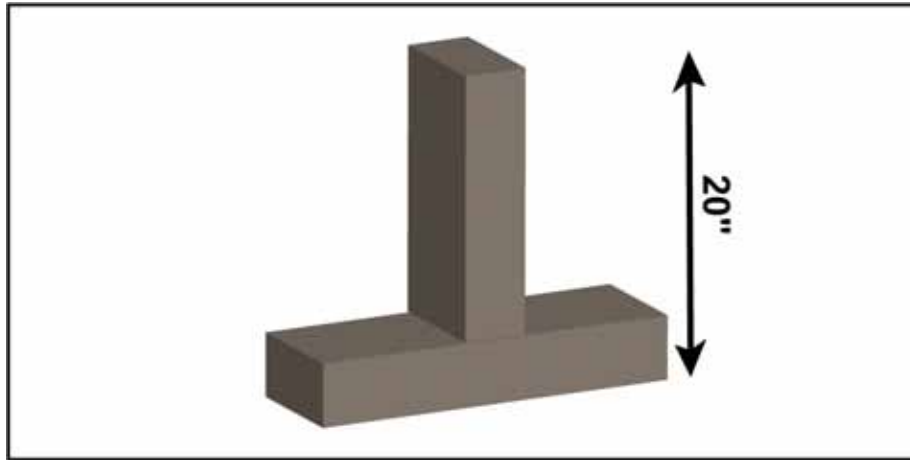

Formación de una pieza de madera en “T”

Para la prueba de seguridad, sujete permanentemente dos piezas de madera para formar una “T”. La “T” deberá ser de al menos 20 pulgadas de alto y ser capaz de mantenerse boca abajo por su cuenta. Vea la Figura de SEGURIDAD-6.

Figura SEGURIDAD-7



Inspección de la cabeza del pórtico

	 DANGER
	<p>Si la cabeza del pórtico falla cualquier parte de esta prueba de seguridad, corrija el problema antes de proceder al siguiente paso.</p> <p>Operar una cabeza del pórtico que ha fallado cualquier parte de la prueba de seguridad podría resultar en una lesión grave o la muerte.</p>

1. Bloqueo y etiquetado del tablero de servicio eléctrico. En la página xvi encontrará un ejemplo de un tablero de servicio eléctrico.
2. Verifique que todas las etiquetas de seguridad sean legibles.
3. Busque signos de daño externo en el escáner láser, los protectores de la máquina, los cables eléctricos y el cableado.
4. Elimine el polvo y las huellas digitales de la ventana del escáner usando un trapo suave y sin pelusas con un limpiador común para plástico y vidrio. NO utilice diluyente, benceno ni acetona para la limpieza debido a que pueden dañar la ventana. En la página 65 encontrará la ubicación de la ventana del escáner.
5. Revise la tensión de la cadena para verificar que sea la correcta. Vaya a la página 57 para ver las instrucciones detalladas.
6. Verifique las condiciones de la presión, la transmisión, la guía y las ruedas guía para asegurar que estén intactas. En la página 76 encontrará una imagen con la ubicación de las ruedas.
7. Revise el tubo de la vía donde las ruedas tocan las mesas para verificar que estén libres de escombros.

Prueba del controlador de seguridad

1. Retire el bloqueo y la etiqueta. Reconecte la electricidad a la cabeza del pórtico.



	 DANGER
	Tome precauciones para asegurar que solo la persona que realiza la prueba esté cerca de la máquina durante la prueba. La energía deberá continuar activa durante la prueba.

2. Verifique que el controlador de seguridad (en el gabinete principal) no indique ninguna falla (luz roja de ERR/ALM, ya sea parpadeando o continua). Vea la Figura de SEGURIDAD-7.

Figura SEGURIDAD-8



3. Siga estos pasos para verificar que el sistema de frenado de la máquina esté funcionando correctamente:



	 DANGER
	¡Nunca se pare directamente frente a la cabeza del pórtico! Los operadores deben asegurarse de que ninguna otra persona se encuentre en la zona de seguridad al realizar estas pruebas. Si la cabeza del pórtico no se detiene en el momento esperado, puede ocurrir una lesión grave o la muerte.

- a) Arranque la cabeza del pórtico moviéndola hacia la derecha (en página lii encontrará paso 2) y continúe hasta que alcance su máxima velocidad.

- b) Oprima el botón de Paro de emergencia y asegúrese de que la cabeza del pórtico se detenga; no debe deslizarse al detenerse. Un deslizamiento puede indicar un problema con la tensión de la cadena o con las ruedas.
- c) Suelte el Paro de emergencia. Presione el botón “Reset” (Restablecimiento).
- d) Repita con la cabeza del pórtico moviéndose hacia la izquierda.

Prueba de los escáneres láser



1. Coloque la pieza de madera en “T” sobre la mesa a cuando menos 10 pies de un escáner. Se debe colocar con un extremo al aire como la pieza en “T” de la Figura de SEGURIDAD-6 en la página xlviii.
2. Mueva la cabeza del pórtico siguiendo estos pasos:
 - a) Suelte el Paro de emergencia. Presione el botón “Reset” (Restablecimiento).
 - b) Revise las luces “Ready” izquierda y derecha a cada lado de la palanca de mando. Ambas luces deben estar encendidas de color verde.
 - c) Presione el botón blanco en la palanca de mando y muévala hacia la pieza en “T”. Continúe moviendo la palanca de mando hacia la pieza en “T”.
3. Verifique que suceda lo siguiente cuando la cabeza del pórtico se acerque a la pieza en “T”:
 - a) La cabeza del pórtico debe reducir la velocidad cuando la pieza en “T” ingrese a la zona de advertencia. En la página 71 y 72 encontrará una imagen de la zona de advertencia.
 - b) Deberá iniciar un paro de emergencia cuando la pieza en “T” ingrese a la zona de seguridad. En la página 71 y 72 encontrará una imagen de la zona de seguridad.

	 DANGER
	<p>Si la cabeza del pórtico golpea la pieza en “T”, bloquee y etiquete de inmediato, y llame al departamento de Servicio a Clientes de MiTek.</p> <p>Operar la cabeza del pórtico después de que ha fallado la prueba de seguridad podría resultar en una lesión grave o la muerte.</p>

- c) Deberá detenerse sin deslizarse y sin golpear la pieza en “T”.
- d) La luz deberá cambiar a rojo.
- e) La luz “Ready” (Listo) más cercana a la pieza en “T” no deberá estar encendida.

4. Revise la estación de control del operador para verificar que la luz “Ready” más alejada de la pieza en “T” esté encendida.
5. Presione el botón “Reset” (restablecimiento). Presione el botón blanco en la palanca de mando y aléjela de la pieza en “T”. Después de un Paro de emergencia, la cabeza del pórtico deberá alejarse de la pieza en “T” y no acercarse a ella.
El botón “Reset” puede liberarse después de que las dos luces “Ready” (izquierda y derecha) estén encendidas de color verde.
6. Repita los pasos 1 a 5 con el escáner al otro lado de la cabeza del pórtico.

Zona restringida

	 DANGER
	<p>Manténgase afuera de la zona restringida cuando el equipo esté en uso. Pueden producirse lesiones graves o incluso la muerte si el personal está en la zona restringida.</p> <p>Asegúrese que no haya personal en la zona restringida antes de operar el equipo.</p>

Conocer la zona restringida

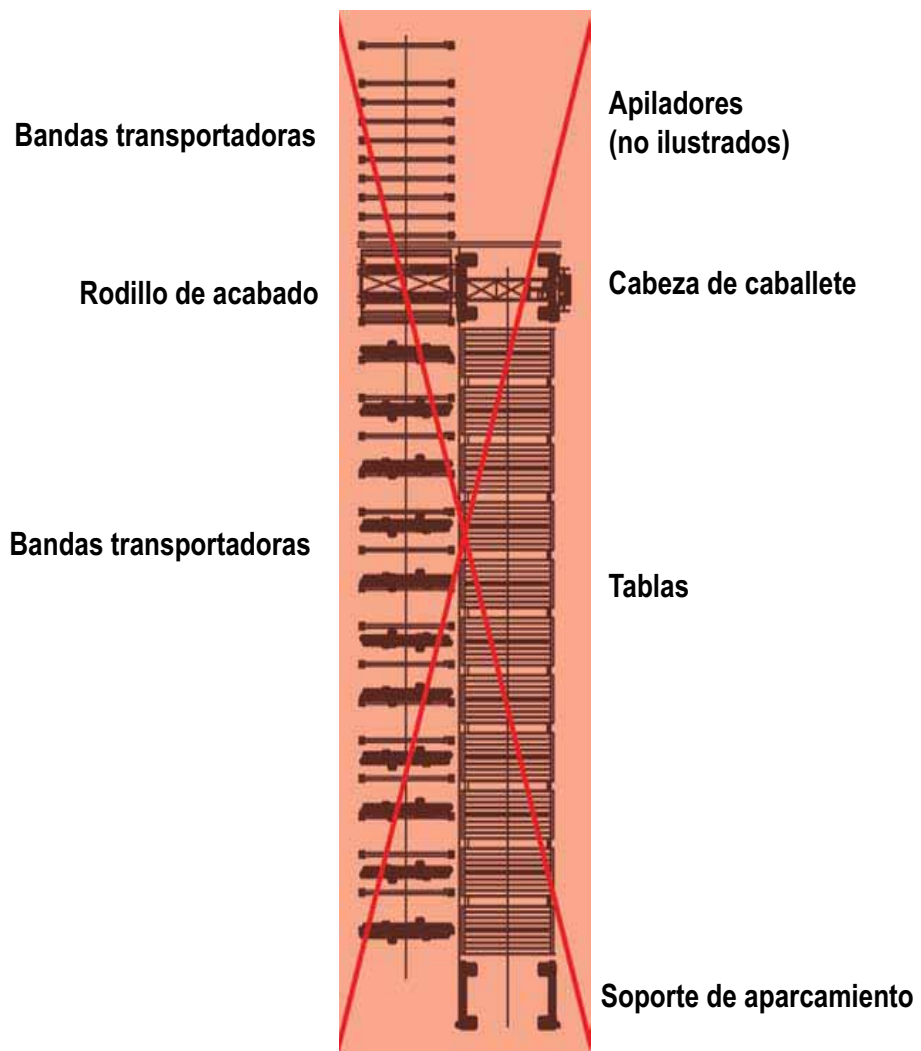

Marcar la zona restringida

Deberá marcarse la zona restringida de manera que todas las personas cerca del equipo puedan ver claramente el área donde pueda existir peligro.

MiTek ofrece la cinta de zona restringida o “Restricted Zone Tape”, fácil de aplicar y con texto en inglés y en español. Algunos equipos traen la cinta de zona restringida. Si su máquina no trajo la cinta de zona restringida, puede pedirla a MiTek Machinery Division Customer Service (Servicio al cliente de la división de maquinaria de MiTek).

Puede encontrar las instrucciones sobre dónde y cómo aplicar la cinta de zona restringida en el manual de su mesa o pórtico incluido con su sistema o pedir el Service Bulletin Kit 181 en la página web de MiTek Machinery.

Información adicional



Definiciones de los símbolos de seguridad
(Safety Symbols Definitions) página xxv

Declaraciones de Cumplimiento
(Declarations of Conformity) página xxxiii

Purpose of Chapter

This chapter explains how to navigate through the equipment manual and how to contact MiTek.

Introduction to the Manual

 WARNING	
	<p>Read this manual completely before using this equipment!</p> <p>Do not operate this machine until you have a thorough understanding of all controls, safety devices, emergency stops, and operating procedures outlined in this manual.</p> <p>All hazard instructions must be read and observed. Failure to do so may result in economic loss, property damage, and/or personal injury.</p> <p>This manual must always be available to personnel operating and maintaining this equipment.</p>

Purpose and Scope of This Equipment Manual

In order for this equipment manual to be useful, it must be accessible. This manual addresses the most recent version of the equipment as of the date listed on the title page. For earlier revisions, contact MiTek Machinery Division.







This manual can be a valuable tool for training.

- The *Introduction* and *General Information* chapters discuss contact information for MiTek, explain truss terminology, and provide information about the equipment.
- The *General* chapter discusses truss terminology and provides some technical data for the equipment.
- The *Operation* chapter teaches operators how to efficiently operate the machine.
- The *Maintenance* chapter is written specifically for maintenance personnel.
- The appendices provide valuable training material and technical information to keep your equipment running.

Navigation

The graphics in Table 1-1 are used throughout the manual to quickly communicate a specific type of information.

Table 1-1: Navigational Tools Used Throughout the Manual

Graphic	Explanation
	<p>Important safety note!</p> <p>Indicates that you must lockout/tagout at the disconnect switch located on the equipment using approved methods described in OSHA 29 CFR 1910.147 before continuing with the procedure.</p>
	<p>Indicates tools required before beginning a procedure.</p>
	<p>Provides additional information for the steps or text.</p>
	<p>Indicates how to get to or from the item discussed.</p>
	<p>Refers the reader to additional pages or resources.</p>
	<p>Indicates that the part number is listed in the <i>Parts List</i> appendix. If viewing the manual electronically, click the icon to be taken to the Parts List appendix. Other part numbers can be found on our web site.</p>

Additional Resources

Web Site

Visit the MiTek Web site at www.mitek-us.com for up-to-date information on all MiTek equipment as well as the following information:

- the latest revision of this manual and most Service Bulletins.
- support, safety, and training information.
- part numbers for ordering maintenance parts.

Contacting Us

For technical assistance or to order parts, contact the Machinery Division Customer Service Department using one of the methods listed in Figure 1-1.



Figure 1-1: Contacting MiTek

<p>MiTek Machinery Division Customer Service Department 301 Fountain Lakes Industrial Drive St. Charles, MO 63301</p> <p>Parts Orders (with part number) E-mail: mitekparts@mii.com</p> <p>Web Site www.mitek-us.com</p> <p>Technical Assistance Phone: 800-523-3380 Fax: 636-328-9218</p>	
--	---

Purpose of Chapter

This chapter provides an overview of the equipment and the means to identify it.

Introduction

 DANGER	
	<p>Read this manual completely before using this equipment!</p> <p>Do not operate this machine until you have a thorough understanding of all controls, safety devices, emergency stops, and operating procedures outlined in this manual.</p> <p>All warnings must be read and observed. Failure to do so may result in economic loss, property damage, and/or personal injury.</p> <p>This manual must always be available to personnel operating and maintaining this equipment.</p>

Introduction to the Equipment

Purpose of the Equipment

The primary function of the *RoofTracker III*™ roof truss roller press system is to press *MiTek*® connector plates into roof trusses to connect roof truss components.

Overview of the Equipment

The *RoofTracker III* roof truss roller press system consists of a gantry head, which houses the roller that embeds the connector plates; tables that hold and support the truss and gantry head; and a parking stand that holds the gantry head while it is not operating. Some systems may have more than one parking stand. The system components can be seen in Figure 2-1 on page 6.

The *RoofTracker III* roof truss roller press system combines with a Stand-Alone Conveyor system to move completed trusses and a Finish Roller that finishes embedding the plates to complete the truss assembly system.

Extent of Manual Coverage for This Equipment

This manual addresses the *RoofTracker III* gantry head. Separate manuals exist for the Finish Roller, Stand-Alone Conveyors, assembly tables, and for any gantry heads used along with the *RoofTracker III* gantry head.

Throughout this manual, the term “press” or “machine” is used to refer to the entire system, and “gantry head” is used to refer to the gantry head, labeled in Figure 2-2 on page 7.

Figure 2-1: Components of a *RoofTracker III* Roller Press System

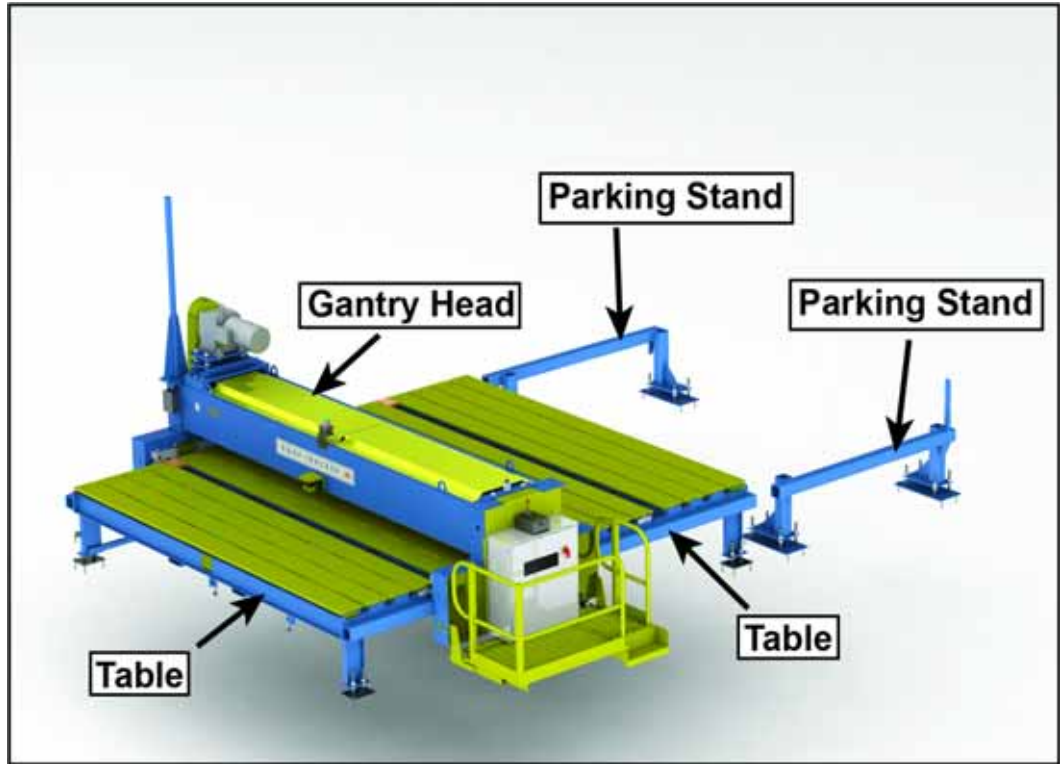
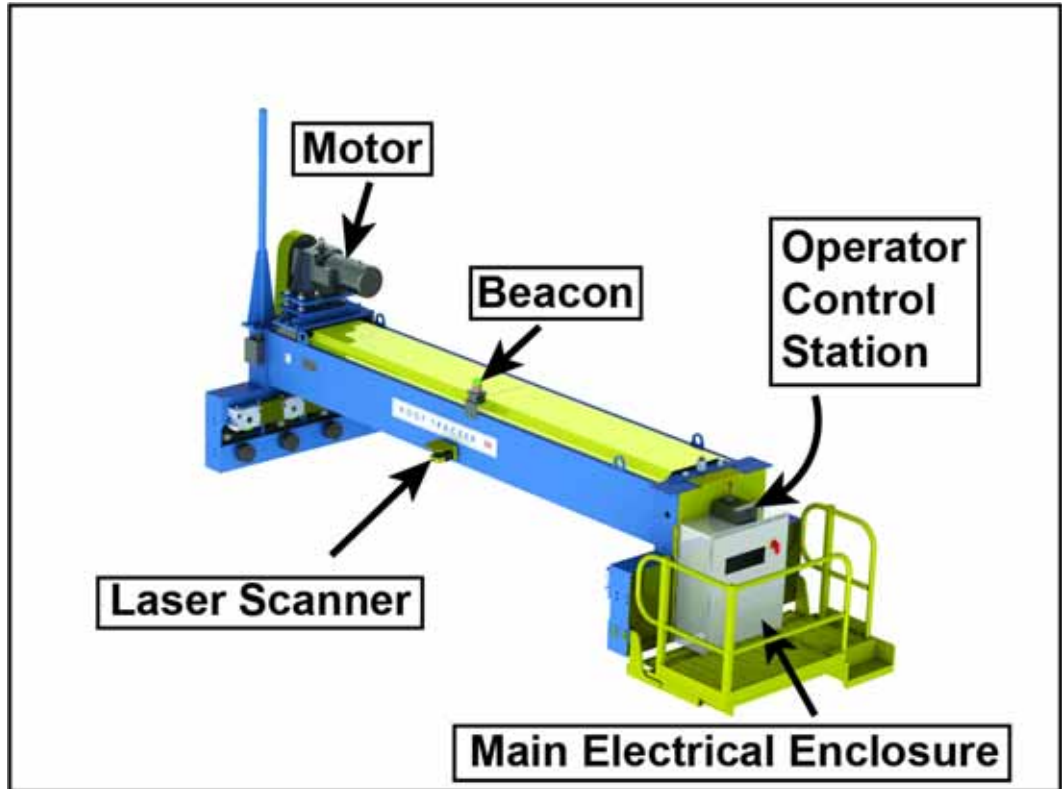

Figure 2-2: RoofTracker III Roller Press Gantry Head



Main Components and Optional Equipment

Table 2-1 lists the main components that comprise all versions of this system. There are options for each of the main components. Contact your MiTek salesperson for more information regarding options.

Table 2-1: Main Components

Component	Description
Gantry head	Moves across the tables to embed plates initially. Includes operator platform and joystick control station. Comes standard with four drive wheels. Some systems have eight drive wheels. Available with 12' 6", 14', or 16' roller.
Tables	Support truss while gantry presses it. Feature slotted tops for jiggling. Feature choices for ejection system.
Parking stands	Provide a parking space for the gantry head so that all working surfaces of tables are accessible.
Gantry lifter	Must be used with end-eject systems. Lifts the gantry head so that assembled trusses have enough clearance to eject.

Platform Options

A platform is attached to the gantry head for the operator to stand on during operation. The standard platform is a bottom-chord platform listed in Table 2-2, but other options are available.

Table 2-2: Platform Options

Platform	Description	Safety
Bottom-chord platform	The most common platform used, it is slightly raised off the floor. It is located on the bottom-chord end of the gantry head, opposite the motor. The electrical enclosure is adjacent to platform.	Laser scanners
Top-chord platform	Platform is located on the top-chord end of the gantry, near the motor. Electrical enclosure is on bottom-chord end.	Laser scanners

Operating Options

If your workflow builds multiple trusses on the same table line, you may want to install multiple gantry heads that use the same tables and conveyor system to give your plant more flexibility.

The *RoofTracker III* press may be used in conjunction with a *RoofTracker* press, *RoofGlider*® press, or an *AutoPress*™ machine.

The *RoofTracker III* press may be used on *AutoPress* tables, although the *Auto Press* may not be used on tables designed for the *RoofTracker*.

General Specifications

Table 2-3: System Specifications

Specification	Technical Data
Speed	Up to 165 FPM
Direction of movement	Left and right (forward and reverse)
Roller height adjustment	4-1/2" of adjustment
Roller diameter	24"
Roller wall thickness	3/4"
Baffles per roller	4
Throat opening	14-1/2' wide
Bearing size for roller	3-7/16"
Electrical specifications	See Table 2-4 on page 10
Physical dimensions	See Table 2-5 on page 10
Weight of equipment	See Table 2-6 on page 10

Table 2-4: Physical Specifications for the Gantry Head (Approximate)

Dimension	Bottom Chord Platform	Top Chord Platform
Roller	14'	14'
Throat opening	14' 10"	14' 10"
Overall length	19' 5"	20' 1"
Overall width	5' 11"	9' 9"
Overall height	7'	6' 8"
Part No.	67390-601-xxxV	67390-501-xxxV

Note: these specifications are for the gantry head with a 14' roller. The gantry head is available with a 12' 6" or 16' roller as well.

Table 2-5: Electrical Specifications for the Gantry Head

Voltage (VAC)	208	230	415	460	575
Horsepower (hp)	15	15	15	15	15
FLA plus controls (amps)	42	38	23	23	17
Disconnect switch fuses on gantry head (amps)	60	60	35	35	25
Cycles (Hz)	60	60	50	60	60
Phases	3	3	3	3	3

Table 2-6: Weight Specifications for the Gantry Head (Approximate)

Component	Weight
Gantry head	10,000 lbs

Truss Terminology

Table 2-7: Truss Terms Used in Figure 2-3

Length Types	Height Types	
Overall length	H1	Board height
Centerline length	H2	Centerline height
Top length	H3	Centerline height
Bottom length	H4	Centerline height

Figure 2-3: Terminology Diagram

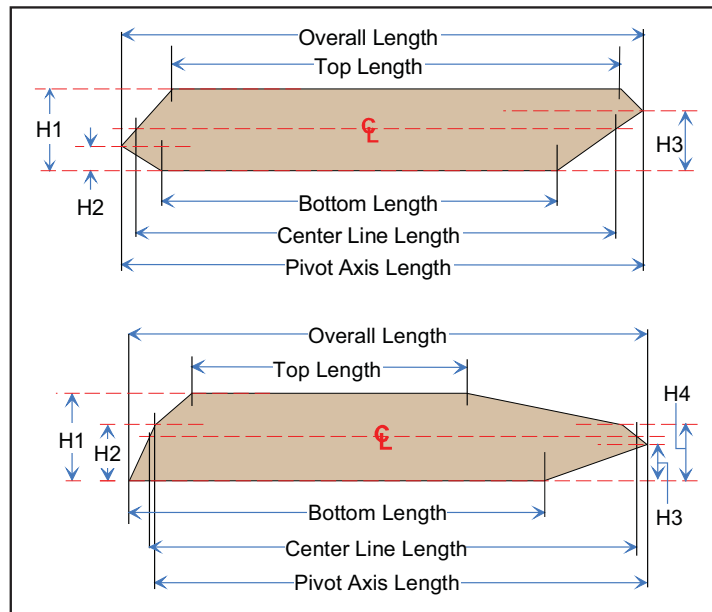
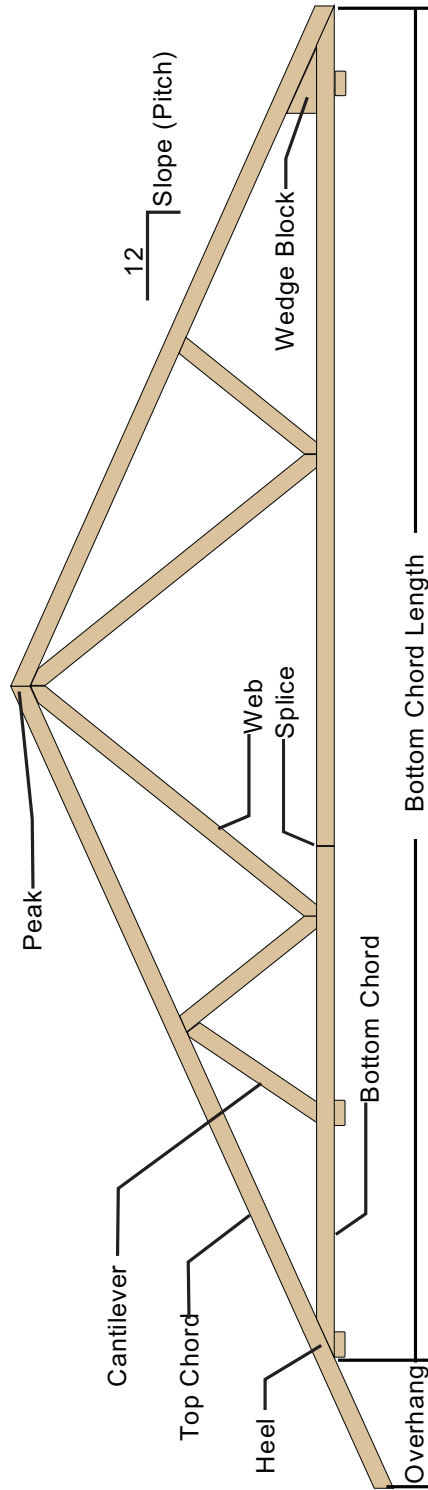

Figure 2-4: Parts of a Truss





Purpose of Chapter

This chapter provides a brief overview of responsibilities during the installation process.

Responsibilities During Installation

MiTek supervises installation to ensure that the *RoofTracker III* gantry head is installed properly and that it operates properly. MiTek also provides operating and maintenance training at the time the gantry head is installed. The customer is responsible for providing all labor and equipment needed to complete the installation.

Responsibilities Before Moving or Selling

	 WARNING
	<p>Call MiTek Machinery Division Customer Service before moving equipment.</p> <p>Moving equipment without proper planning may result in equipment damage or serious injury.</p>



Machinery Division
Customer Service
is available at
800-523-3380
Monday through
Friday.

If you determine that you want to move your *RoofTracker III* system to another location or you want to sell your system to another company, please call customer service. Customer service provides detailed information that is needed before installing the system elsewhere.

Marking Restricted Zone

Marking Area On Your Own

The restricted zone must be marked so everyone near the equipment can clearly see the area where danger may exist. The customer is responsible for marking the restricted zone.

Installing MiTek Restricted Zone Tape

Your equipment arrived with Service Bulletin SB181, which includes restricted zone tape and instructions for installing it. The part number is listed on page 101.



The service bulletin is available online (www.mitek-us.com) as well as through the MiTek Customer Service Department. Follow the instructions contained in SB181 to install the restricted zone tape.



Machinery Division
Customer Service is
available Monday
through Friday
at **800-523-3380**.

Purpose of Chapter

This chapter describes the procedures required before operating your equipment.

	 DANGER
	<p>Do NOT attempt to start the system without a MiTek representative present. Starting the system without a MiTek representative present may result in serious injury and/or equipment damage.</p>

Checking Motor Rotation

Check the motor rotation of the brake motor to make sure that it rotates in the same direction as the arrow on its housing. If the motor rotates in the wrong direction, switch any two lead wires to reverse the direction of the motor.

Setting Pneumatic Pressure for Gantry Lifter

End-eject systems are equipped with a gantry lifter. The pneumatic pressure must be correctly set before operating. The incoming pressure source should be providing air at 100 psi. The regulators for each air bag should be set to 40 psi.

The speed control muffler controls the speed of the gantry lifter as it lowers. See Figure 4-1 on page 16 for the location of the speed control muffler. The gantry lifter motion should be smooth. If the gantry lifter jars or rattles the gantry head, adjust the speed control muffler.

1. Loosen the nut on the speed control muffler.
2. Adjust the speed.
 - Turn the screw clockwise to slow the gantry lifter down.
 - Turn the screw counterclockwise to speed the gantry lifter up.
3. Tighten the nut.

The flow controls upstream from the regulators inflate the air bags and control the speed of the gantry lifter as it rises. If the gantry head rattles or the lifter does not operate smoothly, adjust the speed using the flow control.

- Turn the knob clockwise on the flow control to slow the speed.
- Turn the knob counterclockwise to increase the speed.

Figure 4-1: Speed Control Muffler and Flow Control on Gantry Lifter

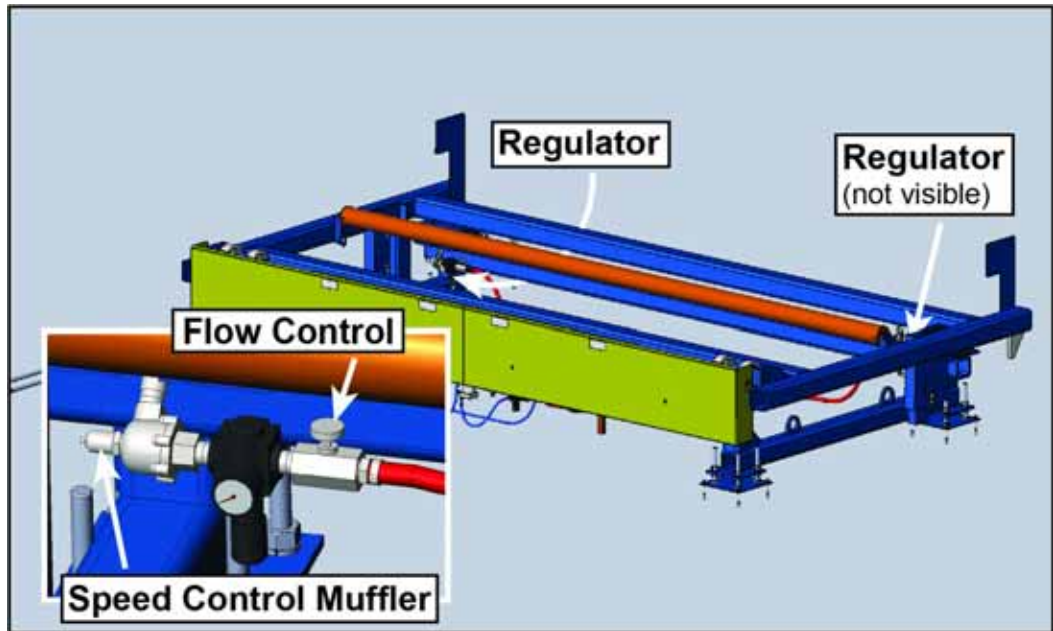

Safety Tests

Perform the safety tests in the *Safety Tests* section on page xviii before the initial startup and after any maintenance. The safety tests also need to be performed in accordance with the maintenance schedule.

Purpose of Chapter

This chapter describes the operating mechanisms on this equipment and the procedure to operate it in most circumstances.



Before You Begin

Understanding This Chapter

Once the installation and startup procedures are complete, the equipment is ready to operate. The following sections provide instructions for everyday operation of the *RoofTracker III* press.

Operating Notes

	<p>After installation of the <i>RoofTracker III</i>, do NOT allow the gantry head to sit in one place for more than three days. Leaving the gantry head sitting for longer may cause flat spots to form on the polyurethane wheels.</p>
---	---

	<div style="background-color: red; color: white; padding: 5px; text-align: center;">  DANGER </div> <p>Read this manual completely before using this equipment!</p> <p>Do not operate this machine until you have a thorough understanding of all controls, safety devices, emergency stops, and operating procedures outlined in this manual.</p> <p>All warnings must be read and observed. Failure to do comply with the warnings so may result in economic loss, property damage, and/or personal injury.</p> <p>This manual must always be available to personnel operating and maintaining this equipment.</p> <p>Before turning the machine on, make sure that all personnel and equipment are clear.</p>
---	---

Stopping the Machine

Stopping During Normal Operation

To increase the life of machine components (such as brake pad, bearing, chain, wheels, motor, etc.) significantly, follow these guidelines when stopping the gantry head during normal operation:



- To stop the gantry head during normal operation, release the joystick while both Ready indicator lights are illuminated and let the gantry head coast to a stop. Releasing the joystick without both Ready indicator lights illuminated triggers an E-stop. Do not use the E-stop for routine stopping as this will cause unnecessary wear on components.
- To park the gantry head on the parking stands, release the joystick with sufficient time for the gantry head to stop. Moving the gantry at full speed onto the parking stand initiates an E-stop and causes unnecessary wear.

Stopping for Emergencies or for Shutdown

During normal operation, the gantry head decelerates to a stop when you release the joystick or the button on the joystick. For safety reasons, the following method can also be used to stop the machine, or the disconnect switch can be used to turn off power when the machine is not in use.

Emergency Stop

Push the red emergency stop (E-stop) button next to the joystick to cease power to the control circuit and stop motion of the gantry head. To release the E-stop, pull up on the pushbutton so it returns to its raised position. The E-stop button on the joystick control panel is shown in Figure 5-1 on page 19.

	 WARNING
	<p>CRUSH HAZARD.</p> <p>The scanners are for detection of personnel and equipment entering a restricted area. They are not for the detection of hands and fingers only.</p>



Refer to page 65 for more information on the laser scanner.

Laser Scanner

The laser scanners are safety devices that scan the safety zones for obstructions. A scanner triggers an emergency stop if it detects an obstruction. The gantry, however, can still move in the opposite direction of the obstruction if the Reset button is held, the joystick button is held, and the joystick is moved in the opposite direction of the obstruction.

Figure 5-1: E-Stop and Scanner

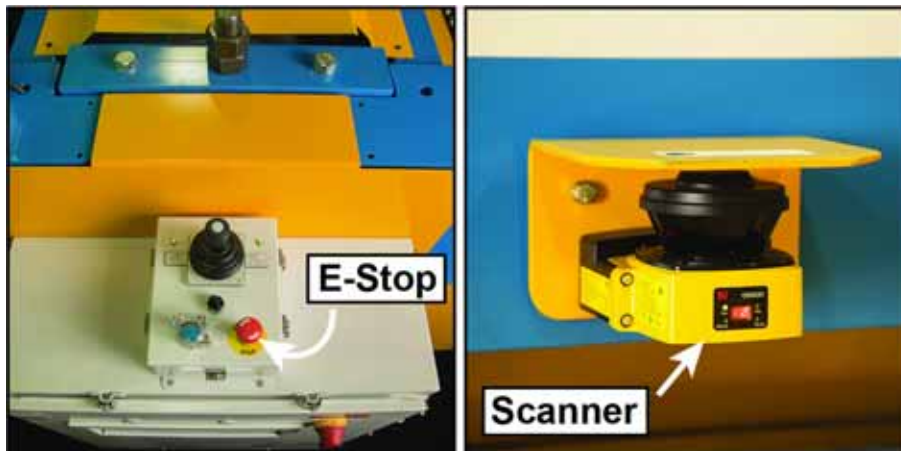

Disconnect Switch

The disconnect switch is located on the main electrical enclosure. See [Figure 5-2](#).

Turning the disconnect switch to the On (vertical) position supplies electrical power to the entire machine.

Turning the disconnect handle to the Off (horizontal) position cuts power to the entire machine. The disconnect switch should always be turned off when the machine is not in use.

Figure 5-2: Disconnect Switch



Indicators

Beacon

The beacon is located on the operator end or middle of the gantry head, depending on the location of the operator platform. The beacon displays three colors. It flashes these colors to represent the gantry head's status. See Figure 5-3 for a beacon attached to the operator end of a gantry head.

Table 5-1: Beacon Colors

Light	Machine status
Blinking red	Machine is experiencing an emergency stop or VFD fault
Solid green	Machine is free to move with no obstructions
Blinking yellow	Machine is running

Figure 5-3: Beacon and Horn



Horn

The horn is located on the underside of the main electrical enclosure. See Figure 5-3. It sounds for a few seconds prior to machine movement. When the horn stops, the gantry head begins motion.

Safety Controller Indicator Lights

The safety controller ensures that the safety features on this machine are working properly. It is located in the main electrical enclosure. Indicator lights on the front of the safety controller unit communicate the operating mode and errors that may occur. Refer to page 90 for more information on troubleshooting the safety controller.

Operator Control Interface Mechanisms

Getting Familiar with Operation

Your *RoofTracker III* press is operated by a joystick. The joystick is mounted on a panel attached to the gantry head called the operator control station (or operator station).

A platform is attached to the gantry head for the operator to stand on.



Figure 5-4: Joystick and Control Panel



Reset

The blue Reset button enables all safety monitoring devices. The operator must press Reset before the Ready indicator lights will come on.

Type of Stop	Obstruction Removed	Action Needed to Move
Joystick released	N/A	Press white button on joystick and move joystick.
E-stop triggered	Yes	Press and release Reset button. Press white button on joystick and move joystick.
E-stop triggered	No	Press and hold Reset button. Press and hold white button on joystick and move joystick. Release Reset button when both Ready indicator lights are green.

 WARNING	
	<p>Always ensure the restricted zone area is clear of personnel and obstructions prior to pressing the Reset button or pushing the joystick.</p>

Joystick

To operate the equipment with the joystick, check the Ready indicator lights on the operator control station. If they are not illuminated, press and release the blue Reset button. Then, press and hold the white button on the joystick handle while pushing the handle in the direction the gantry head should move. The operator must keep the white button on the joystick depressed for movement to continue.

To stop motion, release the white button on the joystick handle. The gantry head decelerates and comes to a complete stop.

If a scanner has tripped and caused an E-stop, the Reset button needs to be held while the white button on the joystick is depressed and the joystick is moved away from the obstruction. After the gantry moves far enough that both directional indicator lights are green, the Reset button can be released.

Operator Platform

The operator platform is a required feature for a gantry using a joystick operator control station. It is a raised platform on which the operator stands, allowing the operator to ride along with the gantry head as it travels.

The standard platform is located on the bottom-chord side of the table line. See page 8 for other platform options.

Operating Procedure

Operating Under Normal Conditions

1. Turn the disconnect handle to the On (vertical) position.
2. Set up the truss configuration and jiggging. Refer to your tables manual for more detail.
3. Verify the following:
 - The beacon is green.
 - Safety detection zones are clear and all safety devices are in normal operating condition.
 - Both of the Ready indicator lights on either side of the joystick are lit. If they are not, press and release the Reset button.
4. Move the gantry head in the desired direction by using the following steps.



- a) Press and hold the white button on top of the joystick.
- b) Push or pull the joystick in the direction the gantry head should move.
- c) Release the white button or the joystick to bring the gantry head to a gradual stop.

5. Remove the truss from the table and place it on the Stand-Alone Conveyors.
 - a) For systems **without** ejectors, manually slide the truss over onto the conveyors.
 - b) For systems using pneumatic ejectors and receivers:
 - 1) Remove all slider pads and ensure the gantry head is not parked on top of an ejector.
 - 2) Turn the setup's pilot valve handle. Refer to your tables manual for more detail.
 - With end-eject systems (or side-eject that is not an auto-eject), manually push the truss from the ejectors to the receivers or conveyor.
 - With an auto-eject system, the truss will slide onto the Stand-Alone Conveyors automatically.
 - 3) Turn the setup's pilot valve handle back to its original position.
6. Repeat the steps above for the next truss.



Do NOT allow the gantry head to sit in one place for more than three days. Leaving the gantry head sitting for longer may cause flat spots to form on the polyurethane wheels.

Restarting Operation

If the machine stopped because you released the joystick, both Ready indicator lights should still be on. You can continue motion in either direction by pressing the joystick button and moving the joystick in the direction the gantry should go.

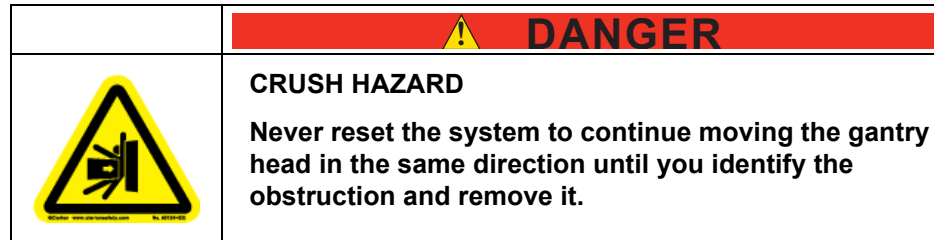

If the machine stopped because a scanner tripped, remove the obstruction and reset the system by following the procedure below. When a scanner on one side of the gantry head trips, the gantry head can still be operated in the opposite direction.

1. Move the gantry head in the opposite direction by using the following steps.
 - a) Press and hold the Reset button.
The Reset button must be held while moving until the gantry head has moved far enough that both Ready indicator lights are green.
 - b) Press and hold the white button on top of the joystick.
 - c) Push or pull the joystick in the direction the gantry head should move.
 - d) Release the white button or the joystick to stop the gantry head's travel.
The deceleration stop feature is suspended until the gantry head stops, the Reset button is pressed, and the gantry head starts moving again.
2. Verify that the green Ready indicator light on the beacon is illuminated. If they are not, there is a physical obstruction or electrical problem.
3. If the green Ready indicator light on the beacon is illuminated, resume operation as normal.

VFD and Brakes

The VFD (Variable Frequency Drive) is inside the main electrical enclosure. See Figure 5-5 for the VFD with its cover removed.

If the VFD experiences a fault, the beacon light blinks red, and a fault description will appear on the VFD display.



See page 62 for more information about the safety controller.

See page 90 for diagnostic indicators.

Safety Controller

The safety controller ensures that all safety features on this machine are working properly. It should not require any additional operation, outside of the normal operating procedures. If the machine will not operate, the safety controller is a good place to start troubleshooting.

Figure 5-5: VFD







Shown with cover removed

Purpose of Chapter

This chapter provides step-by-step instructions as well as information to help you understand how your equipment works to enable you to make repairs and perform preventive maintenance.

This manual contains sufficient information for proper operation and maintenance under most conditions. Certain operating environments may necessitate preventive maintenance at more frequent intervals. Because consistent preventive maintenance is so important for keeping mechanical equipment in good operating condition, *MiTek* recommends that you stock certain replacement parts to minimize downtime. The recommended parts list is in the *Replacement Parts* appendix.

 DANGER	
	<p>Read this manual completely before using this equipment!</p> <p>Do not operate this machine until you have a thorough understanding of all controls, safety devices, emergency stops, and operating procedures outlined in this manual.</p> <p>All warnings must be read and observed. Failure to do so may result in economic loss, property damage, and/or personal injury.</p> <p>This manual must always be available to personnel operating and maintaining this equipment.</p>

 DANGER	
	<p>This equipment can crush or cut. Safety devices reduce the risk of injury.</p> <p>Do not use the equipment unless all safety features are performing correctly.</p>



Refer to page 75 through page 79 for graphics that will assist with understanding this equipment.

Safety Test

The test procedure in the *Safety Tests* section starting on page xviii **MUST** be performed by qualified personnel after ANY maintenance, adjustment, or modification. Testing makes sure that the safety system and machine control system work together to stop the machine properly.

This test should be performed before each shift starts to make sure the safety features remain in working order.

Lubrication

Proper amounts of motor oil and grease must be maintained at all times. The type of lubrication used, frequency of application, oxidation, and contamination of the lubricant affect service life and parts efficiency of gears and bearings. You will obtain improved performance by following the guidelines in this manual.

Lubrication guidelines are given in this chapter for each part or system that requires lubrication. See page 78 and page 79 for lubrication points.

NOTICE

Never mix synthetic lubricants with mineral lubricants!

Brake Motor and Gearbox

The brake motor and gearbox allow the gantry head to start and stop motion.

Certain preventive maintenance is required to keep the motor and gearbox in optimal working order.

Adding and Changing Oil

Check the oil in the gearbox reducer once a month. When additional oil is needed, use the oil recommended in Table 6-1 or a comparable type.

Table 6-1: Standard Oil from Manufacturer

	Standard
ISO Viscosity	VG220
Oil Type	Mineral oil with EP additive
Ambient Temperature	32 to 104°F (0 to 40°C)
Manufacturer / Type	Mobilgear 600XP220

Drain and refill the oil in the gearbox every two years.

Table 6-2: Oil Amount Recommended by Manufacturer

Quarts	Liters
13.7	13.0

Figure 6-1: Brake Motor Oil Maintenance

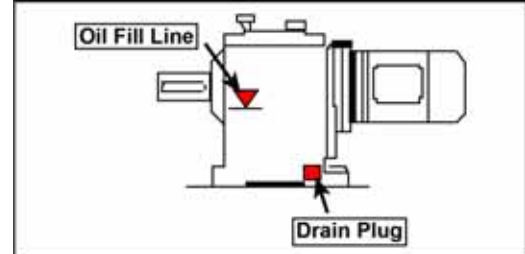

Using the Manual Brake Lever

Release the manual brake lever if you need to push the gantry head manually to a different location along the tables. See Figure 6-2.

Figure 6-2: Manual Brake Lever



Lifting equipment
rated
for 1,200 lbs.

Adjustable
wrench

Torque wrench

1-7/8" wrench

Ratchet set

Phillips
screwdriver set

Slotted
screwdriver set

Level

Tape measure

Masking tape

Permanent
marker

Replacing the Gearbox and Motor

Removing the Old Motor and Gearbox

1. Lockout/tagout all power to the machine.
2. If you are replacing a gearbox and motor on machine with a top-chord operator platform, remove the platform.
3. Remove the motor guard behind the gearbox and the end guard directly underneath that.
4. Remove wiring using the following steps.
 - a) Remove the cover from the junction box.
 - b) Use masking tape and a permanent marker to label the 3-phase wires, brake rectifier wires, and ground wire. Refer to Drawing 90635-501.
 - c) Loosen the screws holding the 3-phase wires, brake rectifier wires, and ground wire in place.
 - d) Remove the nut connecting the conduit to the 90-degree conduit connector. Pull the conduit and remove the wires from the junction box.
 - e) Remove the 90-degree conduit connector from the junction box.



5. Remove the chain, coupling and sprocket by using the following steps.
 - a) Remove the master link and remove the chain from the sprocket.
 - b) Remove the coupling from the shaft by using the following steps.
 - 1) Remove the bolts in the locking holes by turning each bolt 30 degrees at a time in the pattern shown in Figure 6-3.

Turning more than 30 degrees at a time may damage the taper rings in the coupling. Damaged taper rings may keep the coupling from working properly.

Figure 6-3: Bolt Removal Pattern



- 2) Lubricate five bolts and the five unlocking holes with a lubricant that does NOT contain silicone or molybdenum sulfide. See Figure 6-4 for location of the unlocking holes.

Figure 6-4: Unlocking Hole Location and Unlocking Pattern

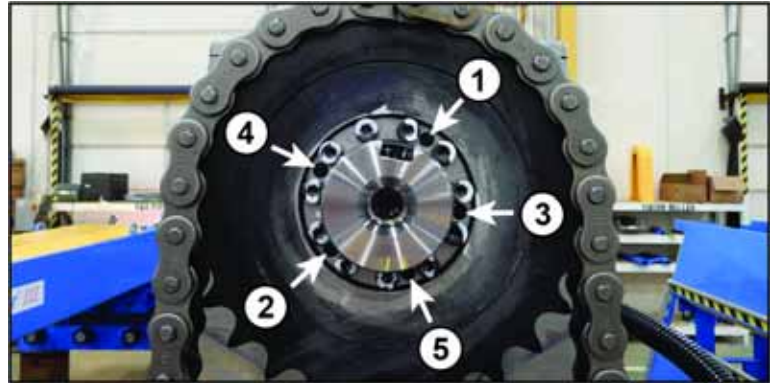

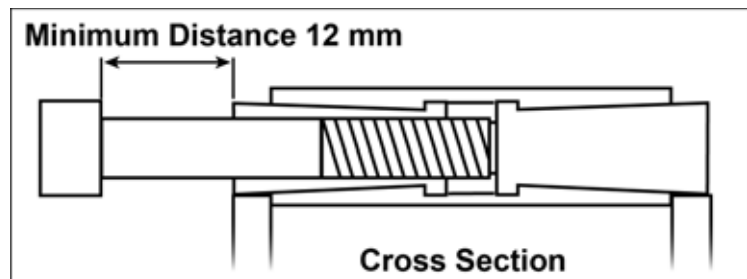

- 3) Tighten the five lubricated bolts in the unlocking holes by hand.

Figure 6-5: Bolt Tightening Distance



- 4) Finish tightening the five bolts by using the following steps. As you tighten, verify the distance indicated in Figure 6-5. Do not tighten past this distance. Over-tightening may damage the coupling.
 - Use a torque wrench to finish tightening the five bolts. Tighten the first bolt 30 degrees.
 - Tighten the next bolt in the pattern shown in Figure 6-4 until all five bolts have been torqued to 30 ft-lbs.
 - While tightening the bolts, the torque should suddenly lighten twice. This indicates that both taper rings are unlocked.
 - If the torque does not lighten, repeat steps 3 through 4, but turn the torque wrench less than 30 degrees at a time.

 CAUTION	
	The coupling can only be installed, removed, and then reinstalled one time.
	Reinstalling a coupling twice may result in equipment damage.



If the original bolts for the coupling are damaged or lost, use only M8X1.00 SHCS X50, Grade 10.9 or 12.9 as replacements.

- c) Remove the coupling from the shaft. Remove the bolts from the coupling.
 - d) Remove the sprocket from the shaft.
6. Run a strap through the eye bolts on the top of the motor. Support the motor and gearbox using lifting equipment rated for 1,200 lbs.
 7. Remove the nuts, lock washers, and bolts securing the gearbox to the plate. Save the nuts, lock washers, and bolts. See Figure 6-6 for the location of the bolts.

Figure 6-6: Bolts Securing the Gearbox to the Plate

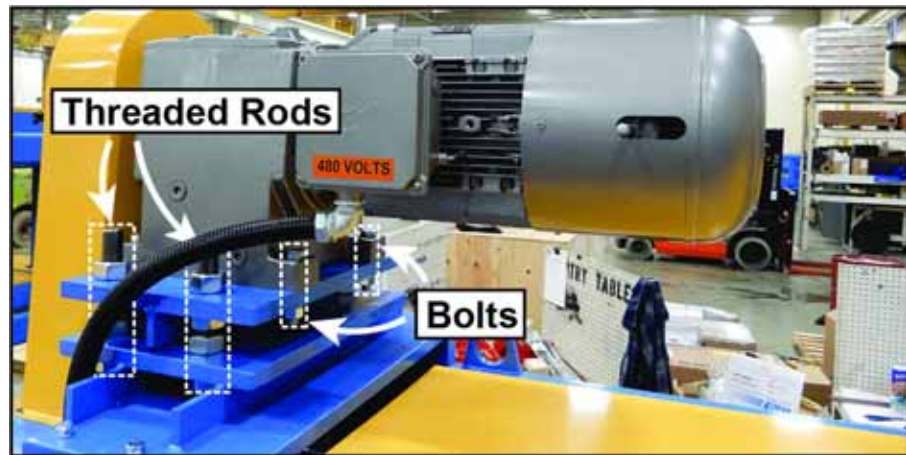

8. Lift the motor and gearbox from the plate. Dispose of it in accordance with local laws and regulations.

Installing a Replacement Gearbox and Motor

1. Clean any debris from the plate.
2. Use lifting equipment rated for 1200 lbs. to lift the new gearbox and motor above the plate. Insert the bolts from the old gearbox at the four corners of the new gearbox.
3. Lower the gearbox and motor onto the plate. Use the nuts, lock washers, and bolts to secure the gearbox to the plate.
4. Reinstall the chain and sprocket by using the following steps.
 - a) Place the sprocket on the shaft.
 - b) Use a yard stick to check the depth of the sprocket on the shaft. The sprocket should be at the same depth as the larger sprocket below.



Do NOT use lubricants with silicone or molybdenum sulfide.

c) After the depth of the sprocket is correct, place and tighten the coupling by using the following steps.

- 1) Clean the inner surface of the coupling and the shaft surface. Lightly oil both surfaces after cleaning.
- 2) Place oil on the bolt threads and between the inner / outer rings and the taper rings. Locations are shown in Figure 6-7 in blue. *Oiling prevents improper torquing due to rough movement of components.*

Figure 6-7: Places to Oil

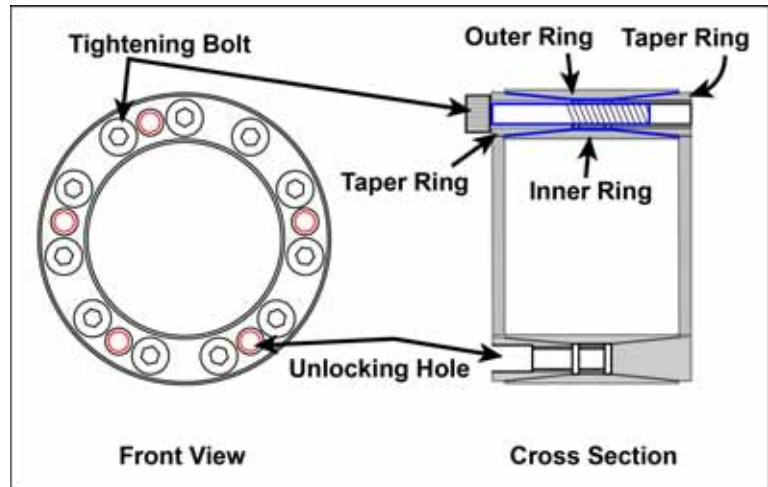

- 3) Tighten two bolts into unlocking holes on opposite sides. Then lightly tighten the remaining bolts into the locking holes.
- 4) Loosen the bolts in the unlocking holes one full turn.
- 5) Support the sprocket so that it does not tilt and deform the coupling. Use the two bolts in the unlocking holes to place the coupling onto the shaft. *Do NOT use a hammer or other tools to drive the coupler onto the shaft. Using a hammer or other tools could deform the coupling.*
- 6) Remove the two bolts from the unlocking holes and lightly tighten them into the two remaining locking holes.

- 7) Torque the bolts in the locking holes by using the following steps.
 - Set the torque wrench to 7.5 ft-lbs. Tighten each bolt 30 degrees at a time in the pattern shown in Figure 6-3 on page 31. Continue to turn each bolt 30 degrees at a time until torque is reached.
 - Set the torque wrench to 15 ft-lbs and repeat the process in step •.
 - Set the torque wrench to 30 ft-lbs and repeat the process in step •.
 - Check that the bolts are all torqued properly to 30 ft-lbs, moving clockwise around the coupling.
- d) Replace the chain.
5. Check to make sure the plate is level. If it is not, loosen the top nuts on the threaded rods, adjust the nuts under the plate, and then tighten the top nuts after the plate is level. See Figure 6-6 on page 33 for the location of the threaded rods.
6. Remove the strap from the eye bolts.
7. Replace the guards.

8. Replace the wires using the following steps. Use Figure 6-8 as a reference.

Figure 6-8: Junction Box

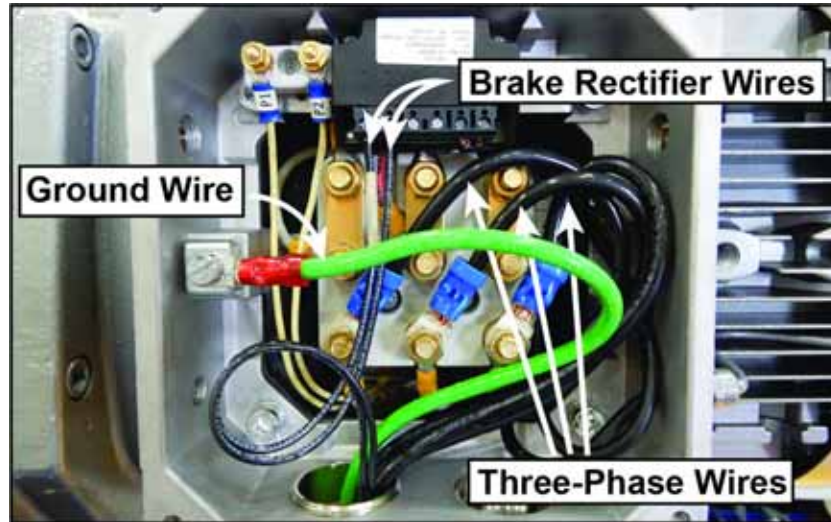

- a) Remove the cover and plug from the junction box.
 - b) Place the 90-degree connector onto the junction box.
 - c) Run the conduit to the 90-degree conduit connector, feed the wires through, and tighten the nut.
 - d) Reconnect the three-phase wires, ground wire, and brake rectifier wires inside of the junction box.
 - e) Replace the cover on the junction box.
9. Remove the lock and tag.
 10. Check to see that the motor runs in the correct direction. If it does not, lockout/tagout and switch any two of the three-phase wires.
 11. Perform the safety test on page xviii. Resume operation.

Replacing a Brake Pad



Slotted screwdriver

Phillips head screwdriver

External snap ring pliers

Metric wrench or pliers

Metric socket head wrench set

1. Unscrew the manual brake handle extending from the side of the brake motor, if there is one.
2. Remove the fan cover.
3. Remove the fan snap ring.
4. Pry the fan off of the motor shaft.
5. Remove the three (3) fixing screws that hold the brake onto the endbell.
6. Slide the brake off of the brake hub.
7. Slide the brake pad off of the brake hub.
8. If there is a metal inner hub, apply silicone grease to the female spline to reduce metal to metal chattering.
9. Slide the new brake pad onto the brake hub.
10. Place the brake onto the motor endbell in the same manner it was removed.
11. After the three (3) fixing screws are tightened, measure the air gap for proper distance. The procedure is described in the *Adjusting the Air Gap* section on page 38.
12. Replace the fan, snap ring and fan cover.

Figure 6-9: Steps 1 through 5

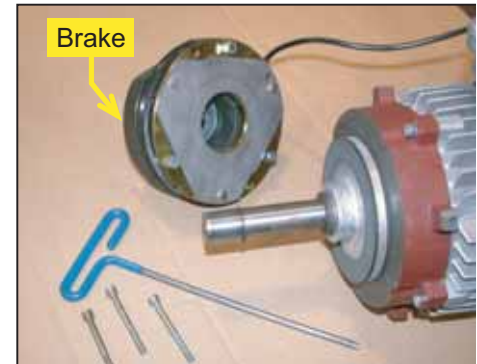

Figure 6-10: Steps 7 and 9

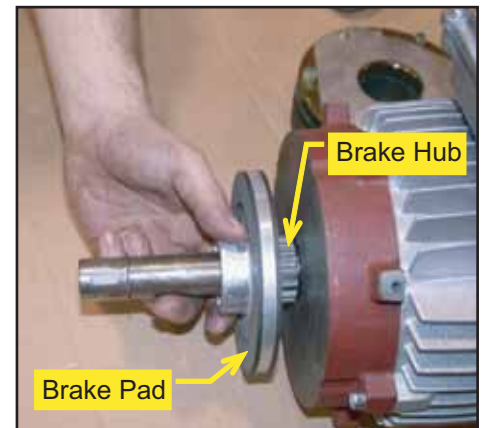

Figure 6-11: Step 12



Maintaining the Air Gap

NOTICE

Adjusting the air gap improperly may damage motor.

Do not attempt to make this adjustment unless the measured gap is outside the recommended allowance.



Slotted
screwdriver

Phillips head
screwdriver

External snap ring
pliers

Metric wrench or
pliers

Metric socket
head wrench
set

Keeping the Correct Air Gap

The air gap in the brake motor may need to be adjusted as the brake pad wears down. The air gap does not affect the stopping distance, but a worn brake pad allows extreme friction on the metal components and will burn up the motor. Check the air gap every 6 months to prevent this costly mistake.

Ways to significantly increase the life of the brake pad:

- To stop the gantry head during normal operation, release the joystick and let the gantry head coast to a stop. Do not use the E-stop for routine stopping as this will cause unnecessary wear on the brake pad.
- To park the gantry head on the parking stands, release the joystick with sufficient time for the gantry head to stop. Do not allow the parking stand flag to trigger an E-stop. Allowing the flag to trigger an E-stop causes unnecessary wear on the brake pad.

Adjusting the Air Gap

The recommended air gap allowance is between 0.016" and 0.043". To check the current air gap and to adjust it, refer to Figure 6-12 on page 39 and the following procedure.

1. Unscrew the manual brake handle extending from the side of the brake motor, if there is one.
2. If the measurement is outside the allowance recommended at any point around the circumference of the brake, adjust the brake disk air gap using the following steps:
 - a) Remove the fan cover.
 - b) Remove the fan snap ring.
 - c) Pry the fan off of the motor shaft.

- Using a feeler gauge, measure the gap between the armature disk and brake housing, shown in Figure 6-12. Measure completely around the brake and record any variations in the gap measurement.

Figure 6-12: Measuring the Brake Disk Air Gap

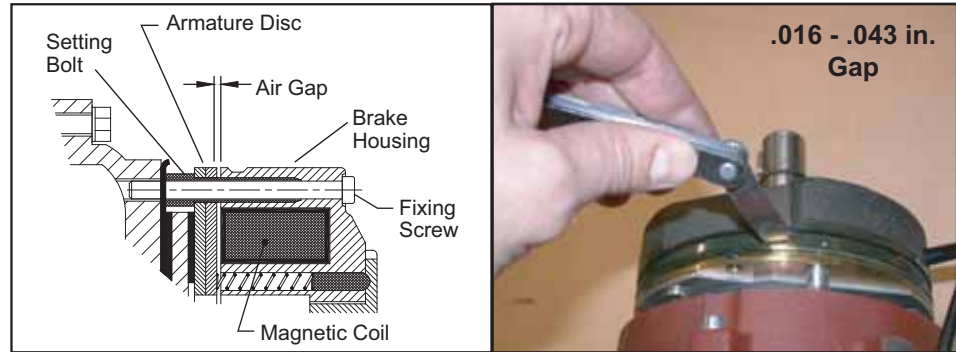

- Adjust the setting bolts as needed to reach the recommended gap. A 1/4 or 1/2 turn is usually sufficient for adjusting purposes. See Figure 6-13.

Figure 6-13: Adjusting the Setting Bolt



- Check the air gap again to ensure it is now within the recommended range. It may be necessary to adjust a setting bolt more than once because the other setting bolts may affect it.



The air gap distance must be the same in all three (3) places!

- Tighten all of the fixing screws.
- Re-attach the fan blades, snap ring, fan cover, and handle.

Drive Wheels and Idler Wheels

Drive wheels control the movement of the gantry head. They are driven by a drive chain. The idler wheels are in line with the drive wheels and assist in supporting the gantry head.

The gantry head has either two drive wheels and two idler wheels (2WD) or four drive wheels (4WD) and no idler wheels per side. Drive wheels have a shaft attached to them, while idler wheels do not. See Figure 6-14.

Figure 6-14: Wheel Blocks

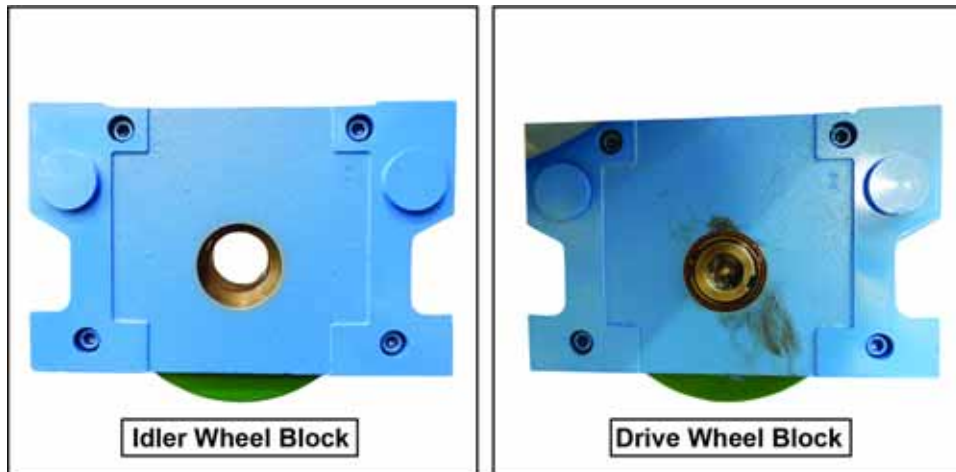

Viewed from inside of gantry.

Lubricating

All drive wheel shafts and bearings must be greased approximately once a year (one shift per day) or once every six months (two shifts per day) with a #2 lithium-based grease. Grease points are shown on page 79 at the end of the *Maintenance* chapter.

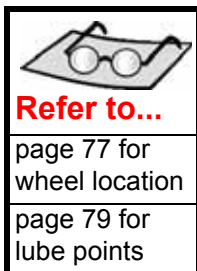

1. Park the gantry head in a parking area.
2. Remove power and lockout/tagout the machine.
3. Using a standard grease gun, grease the fitting on the shaft of each drive wheel from the roller side of the gantry head. Each of these grease fittings must be greased individually. Do NOT over-grease.
4. From the outer side, remove both end guards and grease the bearings on all drive wheels.
5. Replace the guards and remove the lockout/tagout devices.



Replacing an Idler Wheel or Idler Wheel Block

NOTICE

If you intend to replace only the idler wheel, this procedure requires an arbor press and non-marring block for the press (shown in Figure 6-26 on page 50). Using other methods to complete this procedure may damage the idler wheel block.

Removing the Old Idler Wheel Block



Socket wrench set

Standard Allen wrench set

Pry bars (2)

C-clamps

Thread adhesive

Arbor press

Non-marring block for arbor press (see Figure 6-26 on page 50)

1. Move the gantry head so that the idler wheel is positioned in the middle of the gap between the parking stand and the adjacent table.
2. Lockout/tagout on the disconnect switch on the gantry head's main electrical enclosure.
3. Remove the end guard on the outside of the gantry head to expose the frame behind the idler wheel block. Save all hardware for reinstallation later.
4. Remove the idler wheel block by using the following steps.
 - a) Use a socket wrench to loosen the screws on the top of the idler wheel block. See Figure 6-15.

Figure 6-15: Idler Wheel Block

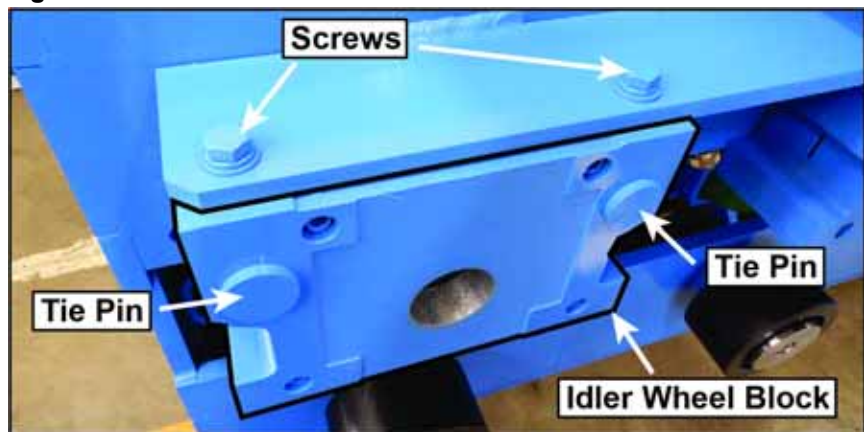

- b) Use a socket wrench to remove the nuts and washers from the tie pins on the rear of the idler wheel block. See Figure 6-16.

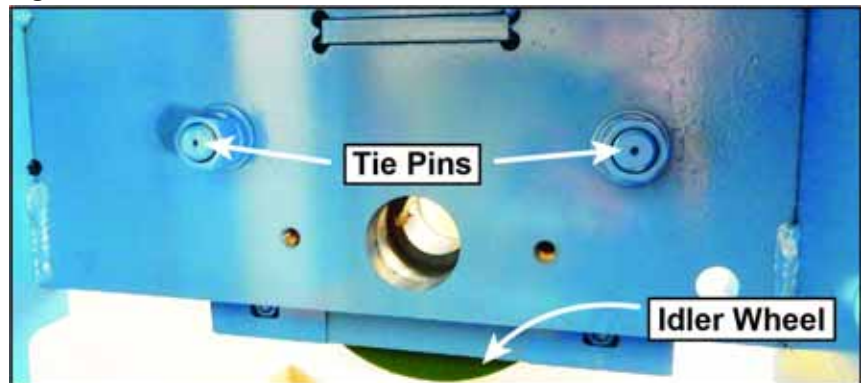
Figure 6-16: Rear of Idler Wheel Block

- c) Remove the two screws and their washers from the top of the idler wheel block. Pull the block forward to remove it.
5. Pull the tie pins from the idler block. If you are replacing the entire idler wheel block, continue with the steps below. If you are replacing the idler wheel only, skip to the Replacing Only a Drive or Idler Wheel procedure on page 48.

Reinstalling an Idler Wheel Block

1. Reinstall the idler wheel block by using the following steps.
 - a) Support the wheel block. Slide it into place on the frame. Insert the screws with their washers on the top of the block. Tighten the screws on the top of the block.
 - b) Insert the tie pins into the holes in the idler wheel block. Push them in so that they protrude through the tie pin holes on the frame.
 - c) Tighten the nuts and washers on the tie pins on the rear of the block.
2. Replace the guard on the side of the gantry head.
3. Remove the lock and tag. Resume operation.

Replacing a Drive Wheel or Drive Wheel Block

NOTICE

If you intend to replace only the drive wheel, this procedure requires an arbor press and non-marring block for the press (shown in Figure 6-26 on page 50). Using other methods to complete this procedure may damage the drive wheel block.

Removing the Drive Wheel Block



Socket wrench set

Standard Allen wrench set

Pry bars (2)

C-clamps

Thread adhesive

Arbor press

Non-marring block for arbor press (see Figure 6-26 on page 50)

1. Move the gantry head so that the drive wheel block is positioned in the gap between the parking stand and the adjacent table.
2. Lockout/tagout on the disconnect switch on the main electrical enclosure.
3. Use an Allen wrench to remove the screws securing the applicable end guard to the gantry head's frame.
4. Reduce the tension on the drive wheel chain by using steps 2 and 3 on page 57.
If you have a four-wheel-drive gantry head, reduce chain tension on the secondary drive wheel chain.
5. Use pliers to pull the cotter pins or clip from the master link. See Figure 6-17. Remove the master link. Remove the drive wheel chain from the sprocket.
If you are working on the double sprocket of a four-wheel-drive gantry head, repeat this step with the secondary drive wheel chain as well.

Figure 6-17: Master Link

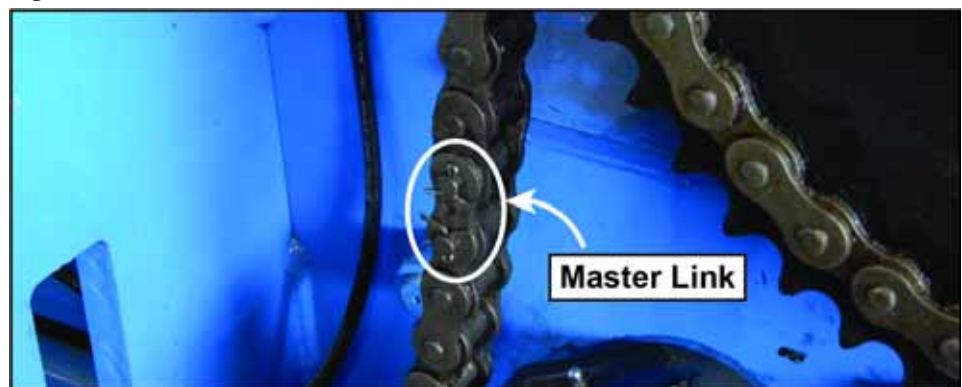

6. Prepare the drive wheel shaft for removal by using the following steps.
 - a) Use an Allen wrench to loosen the split collar on the end of the shaft. Pull the split collar from the shaft. See Figure 6-18.
If you are working on the double sprocket of a four-wheel-drive gantry head, the split collar is located behind the double sprocket. Remove the screw and locking hub from the front of the double sprocket for now.

Figure 6-18: Split Collar on Drive Wheel Shaft

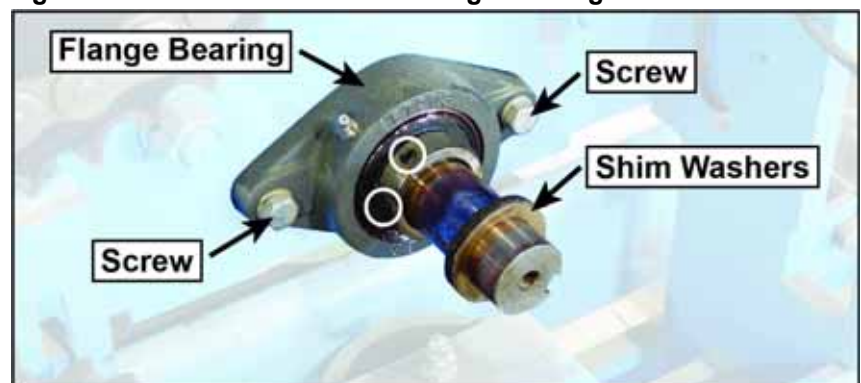

Four-wheel-drive gantry heads vary slightly from the above graphic

- b) Loosen the two set screws located in the sprocket hub. Remove the sprocket.
- c) Remove the key and shim washers from the shaft. See Figure 6-19.
If you are working on the double sprocket of a four-wheel-drive gantry head, remove the key and split collar now instead.

Figure 6-19: Shim Washers and Flange Bearing

- d) Loosen the set screws, circled in Figure 6-19, on the flange bearing.
- e) Use a socket wrench to remove the screws and washers from the flange bearing. Pull the flange bearing from the shaft.
Using penetrating oil on the shaft may make removing the flange bearing easier.

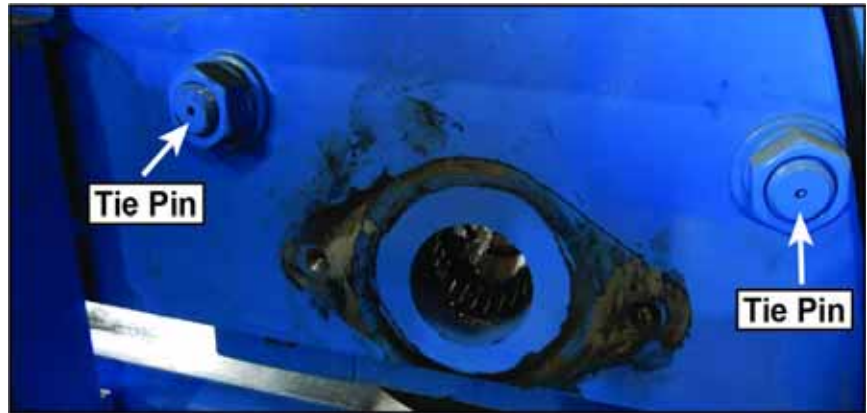
7. Remove the drive wheel block from the frame by using the following steps. Use Figure 6-20 for reference.

Figure 6-20: Tie Pin Nuts

- a) Use a socket wrench to remove the nuts and washers from the tie pins. Tap the tie pins with a hammer to make removal easier.
- b) From the inside of the gantry head, the side closest to the roller, remove the tie pins from the drive wheel block.
- c) Support the drive wheel block to prevent it from falling. Use a socket wrench to remove the two screws and washers that attach the drive wheel block to the frame. The screws and washers are circled in Figure 6-21.

Figure 6-21: Drive Wheel Block Attached to Frame

- d) Pull forward and down on the drive wheel block to remove it.
8. Depending on the component that you are replacing, continue in one of two ways.
 - If you are replacing the entire drive wheel block, continue to Reinstalling a Drive Wheel Block on page 46.
 - If you are replacing the drive wheel only, go to Replacing Only a Drive or Idler Wheel on page 48.

Reinstalling a Drive Wheel Block

1. Replace the drive wheel block by using the following steps.
 - a) Insert the drive wheel shaft through the hole in the frame. Slide the drive wheel block back onto the frame. While supporting the drive wheel block, insert and hand-tighten the screws that attach the drive wheel block to the frame. See Figure 6-22.

Figure 6-22: Placing a Drive Wheel Block on the Frame

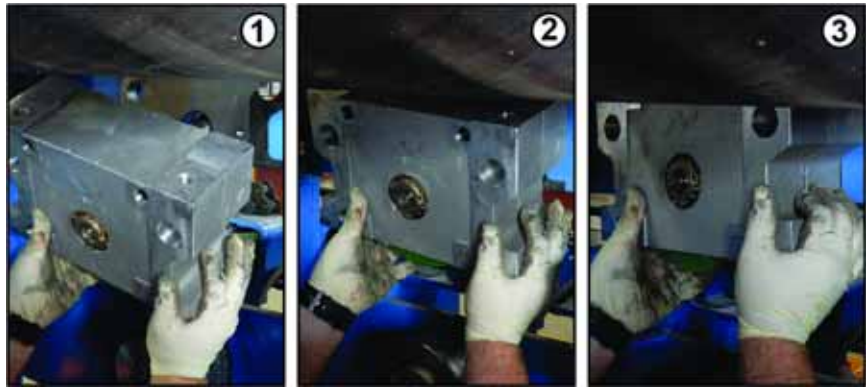

- b) Tighten the screws described in step a completely to align the tie pin holes in the drive wheel block with the tie pin holes in the frame.
 - c) Slide the tie pins into their holes.

The tie pins may require light tapping with a hammer to seat them completely.
2. Move to the outside of the gantry head. Use a socket wrench to tighten the nuts on the tie pins.

3. Replace components on the drive wheel shaft by using the following steps.
 - a) Replace the bearing by using the following steps. Use Figure 6-23 for reference.

Figure 6-23: Flange Bearing

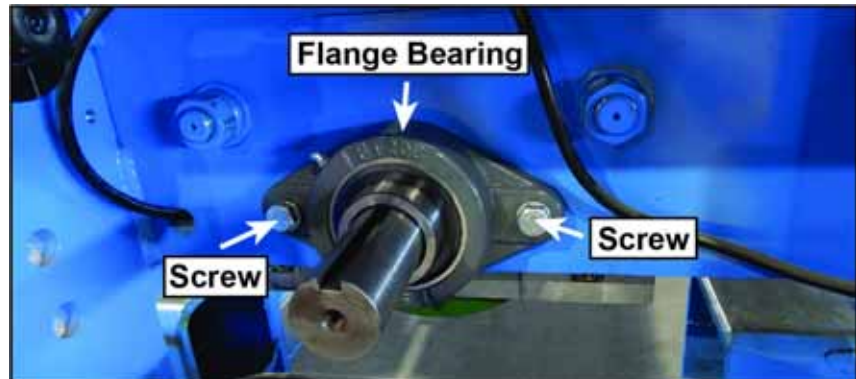

- 1) Slide the flange bearing onto the shaft.
 - 2) Tighten the screws and lock washers to secure flange bearing to the shaft.
 - 3) Tighten the two set screws on the flange bearing.
- b) Replace the shim washers and key onto the shaft.

If you are working on the double sprocket of a four-wheel-drive gantry head, the split collar goes on the shaft at this point. There are no shim washers.
 - c) Slide the sprocket onto the shaft. Use a tape measure to check the sprocket's depth on the shaft to make sure it is even with the adjacent sprocket.
 - d) Tighten the two set screws on the sprocket hub.
 - e) Slide the split collar onto the shaft. Tighten the two screws on the split collar.

If you are working on the double sprocket of a four-wheel-drive gantry head, place the screw, washer, and locking hub on the shaft instead.
4. Reroute the drive wheel chain or chains. Replace the master link on the drive wheel chain or chains.
 5. Tension the drive wheel chain or chains using steps 3 and 4 on page 57.
 6. Remove the lock and tag. Resume operation.

Replacing Only a Drive or Idler Wheel

NOTICE	
	<p>This procedure is part of two larger procedures. You should have removed the wheel block from the gantry head already.</p> <p>For the procedure to replace the idler wheel, see page 41. For the procedure to replace the drive wheel, see page 43.</p>



1. If you are replacing an idler wheel, skip to step 2 on page 49. If you are replacing an drive wheel, continue to step a below.
 - a) Use snap ring pliers to remove the snap rings on both sides of the drive wheel block.

Figure 6-24: Snap Rings on Drive Wheel Block

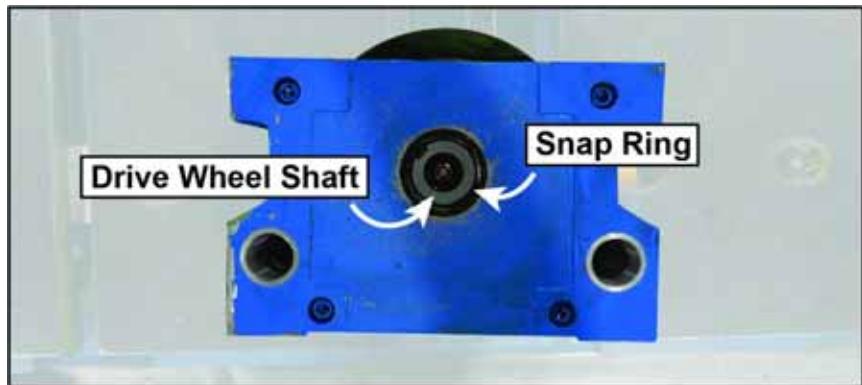

- b) Pull the drive wheel shaft free from the wheel block.

2. Disassemble the wheel block by using the following steps.
 - a) Use an Allen wrench to remove the four screws from the wheel block. See Figure 6-25.

Figure 6-25: Wheel Block with Tie Pins and Screws Removed

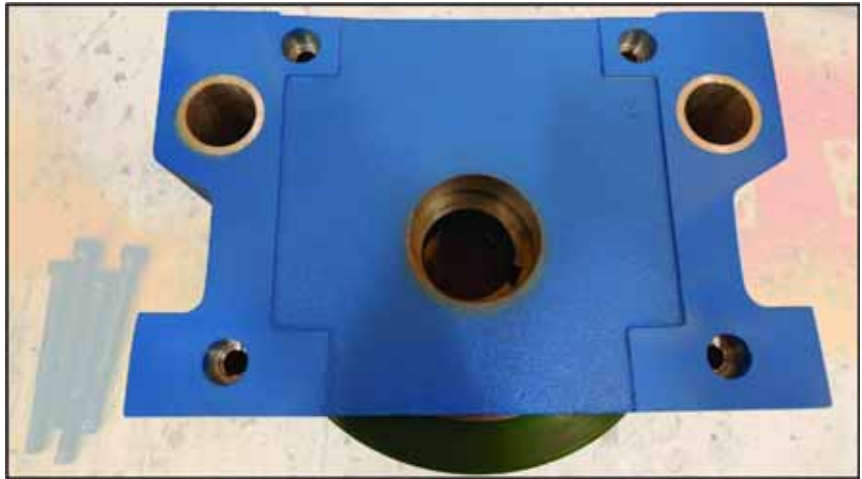

- b) Insert pry bars into the slots at either end of the block. Pry the front half of the block from the rear half of the block.
The halves of the old block are pressed together. Using C-clamps to secure the bottom half of the block to a table makes separation easier.
 - c) Use the pry bars to pry the old wheel from the wheel block.

3. Reassemble the wheel block using the following steps.
 - a) Use an arbor press with a non-marring block to press the new wheel into its block. See Figure 6-26.

Figure 6-26: Pressing the Wheel and Wheel Block

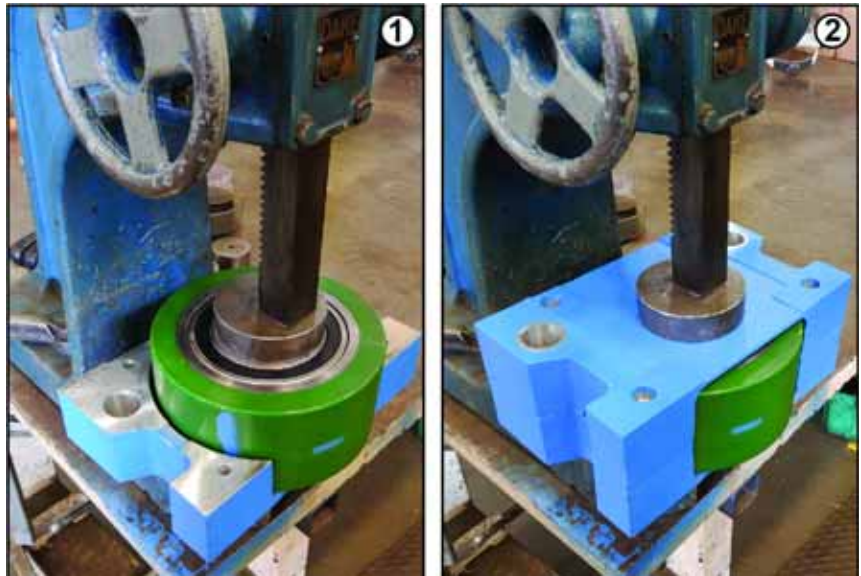

- b) Use the arbor press and non-marring block to press the top half of the block and the bottom half of the block together. See Figure 6-26.
 - c) Slide the tie pins into the block to keep the top and bottom halves aligned. See Figure 6-27.

Figure 6-27: Wheel Block with Tie Pins Inserted

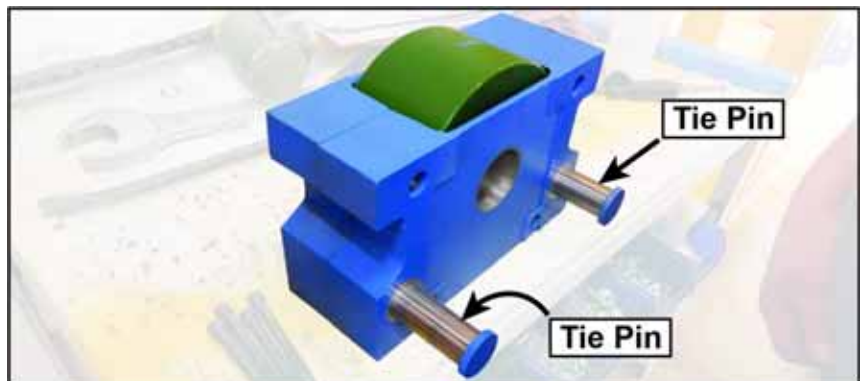

- d) Apply thread adhesive to the four screws from the block. Insert and tighten the screws.
 - e) Remove the tie pins.

4. If you are replacing an idler wheel, return to the procedure starting with Reinstalling an Idler Wheel Block on page 42. If you are replacing a drive wheel, continue to step a below.
 - a) Insert the drive wheel shaft into the wheel block.
 - b) Replace the snap rings on both sides of the wheel block. Return to the procedure starting with Reinstalling a Drive Wheel Block on page 46.

Guide Wheels

Refer to Figure 6-43 on page 77 at the back of this chapter for a diagram of the wheels on the gantry head.

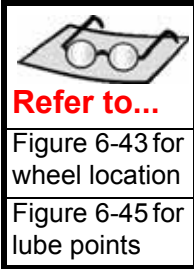

Lubricating

Guide wheels are necessary to keep the gantry head on a straight path when it experiences a force that is not parallel to its forward motion. There are 4 guide wheels on each end (for a total of 8). The guide wheel bearings must be greased approximately once a year (one shift per day) or once every six months (two shifts per day).

Use a #2 lithium-based grease. One (1) grease fitting is located in the center of each guide wheel and is circled in Figure 6-28.

Figure 6-28: Guide Wheel and Grease Fitting

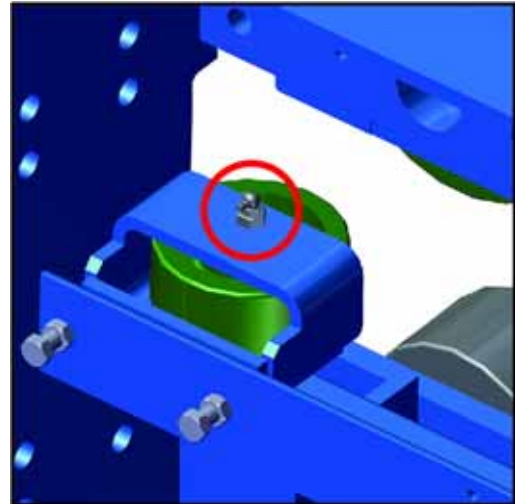

Replacing Guide Wheels



1. If your system does not have a gap between two tables or a gap between the parking stand and tables, skip to step 2. If your system has a gap, move the gantry head so that the guide wheel that you are replacing is positioned in the middle of a gap.
2. Lockout/tagout on the disconnect switch on the main electrical enclosure on the gantry head.



Adjustable wrench
Ratchet set
Allen wrenches

3. Prepare the wheel mount for removal of the wheel by using the following steps. Refer to Figure 6-29 as you prepare the wheel mount.

Figure 6-29: Guide Wheel and Wheel Mount

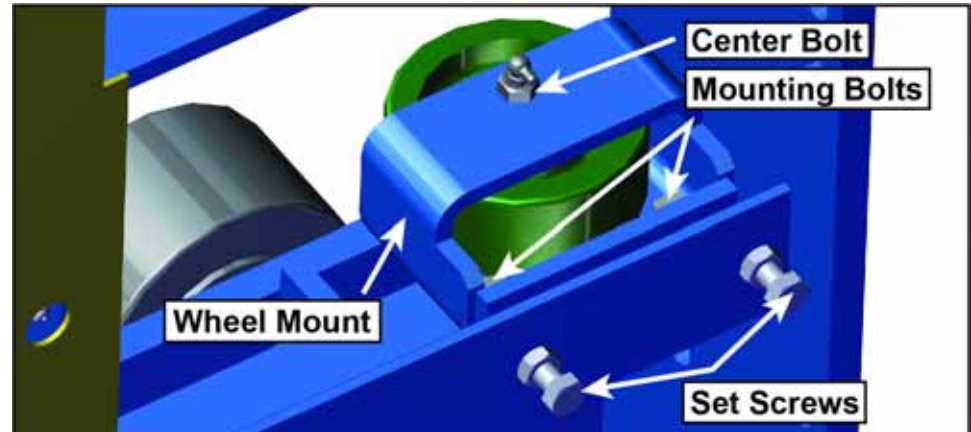

- a) Loosen the nuts on the set screws.
- b) Loosen the set screws several turns.
- c) Depending on your system, loosen or remove components in one of two ways.
 - If your guide wheel is positioned in a gap between tables or a gap between a table and a parking stand, loosen the mounting bolts. Skip to step 4.
 - If your guide wheel is positioned so that it is touching a table, remove the mounting bolts and nuts. Remove the wheel mount.
4. Replace the wheel using the following steps.
 - a) Remove the center bolt from the wheel.
 - b) Remove the old wheel. Insert the new one.
 - c) Insert and tighten the center bolt.
 - d) Depending on your system, complete reinstallation in one of two ways.
 - If your guide wheel is positioned in a gap between tables or a gap between a table and a parking stand, skip to step 5.
 - If you removed the entire wheel mount, replace the wheel mount and replace the mounting bolts and nuts. Do not tighten the mounting bolts. Skip to step 6.



5. Remove the lock and tag from the disconnect switch, move the gantry head slightly so that the wheel is next to a table, and then lockout/tagout on the disconnect switch again.
6. Adjust the set screws to move the wheel mount so that the wheel touches the table. Make sure to adjust both set screws the same amount. Tighten the nuts on the set screws.
7. Tighten the mounting bolts and nuts.
8. Remove the lock and tag. Resume operation.

Pressure Wheels

Refer to Figure 6-43 on page 77 at the back of this chapter for a diagram of the wheels on the gantry head.

Lubricating

Pressure wheels enable the roller to press the connector plates into a truss. There are 4 pressure wheels on each end of the gantry head (for a total of 8). The wheels do not require lubrication.

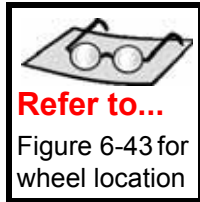

Replacing Pressure Wheels

1. Lockout/tagout on disconnect switch on the main electrical enclosure.
2. Remove the screw shown in Figure 6-30. You may need to heat it to loosen the thread adhesive.



Figure 6-30: Pressure Wheel

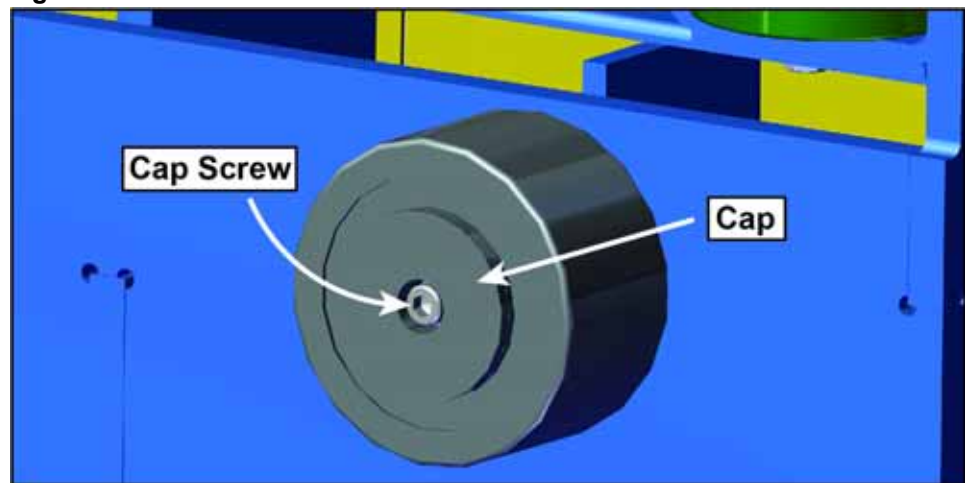

3. Remove the cap.
4. Pull the wheel off the shaft and replace it with a new wheel.
5. Replace the cap.
6. It is recommended that you use red Loctite on the cap screw before securing the wheel block.
7. Replace the cap screw and tighten it to a torque of 85 ft-lbs.

Take-Up Bearing

Lubricating



Refer to...
Figure 6-45 for
lube points

The take-up bearing allows the roller to turn, resulting in smooth embedment of the connector plates. It should be greased approximately once a year (one shift per day) or once every six months (two shifts per day).

Use a #2 lithium-based grease to lubricate the grease block for each take-up bearing. The general location of a grease block is shown in Figure 6-45 on page 79. There is one grease block on each end of the gantry head, for a total of 2.

Adjusting

The procedure for adjusting the take-up bearing to change the height of the roller is described on page 60.

Chains

Three (3) chains are used to operate the gantry head. Two are drive wheel chains and one is a motor drive chain. All are #80 roller chains that require manual lubrication.

Lubricating the Chains



Refer to...
Figure 6-44 for
lube points

The drive wheel chains and the motor drive chain should be lubricated once every month (one shift per day) or once every two weeks (two shifts per day). The lubricant used should be a high-grade, non-detergent, petroleum-base oil. Anti-foam, anti-rust, and film-strength improving additives are often beneficial. SAE 30 grade is recommended.

To apply the oil, brush it on the inside surface of the chain as indicated in Figure 6-44 on page 78. Apply it to the upper edges of the link plates in the lower span of the chain at a point close to where the chain engages a sprocket. Gravity and centrifugal force will aid in carrying the lubricant to the critical pin and bushing surfaces. Do not be concerned about surplus lubricant spilling over the link plate edges as it will lubricate the roller and bushing surfaces.

Adjusting Chain Tension

There is 1 motor drive chain on the motor end of the gantry and 1 drive wheel chain on each end of the gantry head. Check the tension of all 3 chains every week. The optimum chain tension should allow 1/2-in. play (1/4-in. movement to both sides of center).

Adjusting the Drive Wheel Chain Tension

Adjust the chain tension on the drive chains by performing the procedure below while referring to Figure 6-31.



1. Remove the end guard from the gantry head.
2. Loosen the two bolts behind the drive chain tension sprocket.
3. Adjust the drive wheel chain tension by using one of the following. Motor drive chain play should be approximately 1/2 in. (1/4 in. movement to both sides of center).
 - Tighten the tension bolts to push the tension sprocket up and increase tension.
 - Loosen the tension bolts to push the tension sprocket down and decrease the tension. You may have to tap the sprocket with a rubber mallet to move it down.
4. Tighten the two bolts behind the drive chain tension sprocket.
5. Check the tension of the motor drive chain on the other end of the *RoofTracker III*. Repeat if the chain tension does not match the description in the optimum chain tension described above.

Figure 6-31: Drive Wheel Chain Tensioning

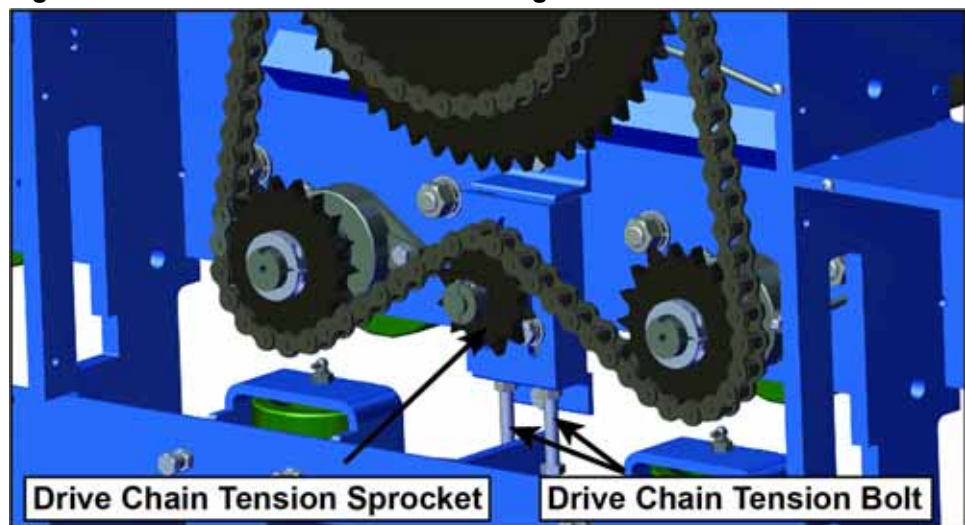



Adjusting the Motor Drive Chain Tension

1. Loosen the top nuts on each of the jack bolts shown in Figure 6-32.
2. Raise the middle nut on each jack bolt to raise the motor plate. Ensure they are even and the motor plate is level.
3. Tighten the top nuts snug against the top of the motor plate.
4. Tighten the bottom nuts snug against the middle nuts.

Figure 6-32: Adjusting the Motor Drive Chain

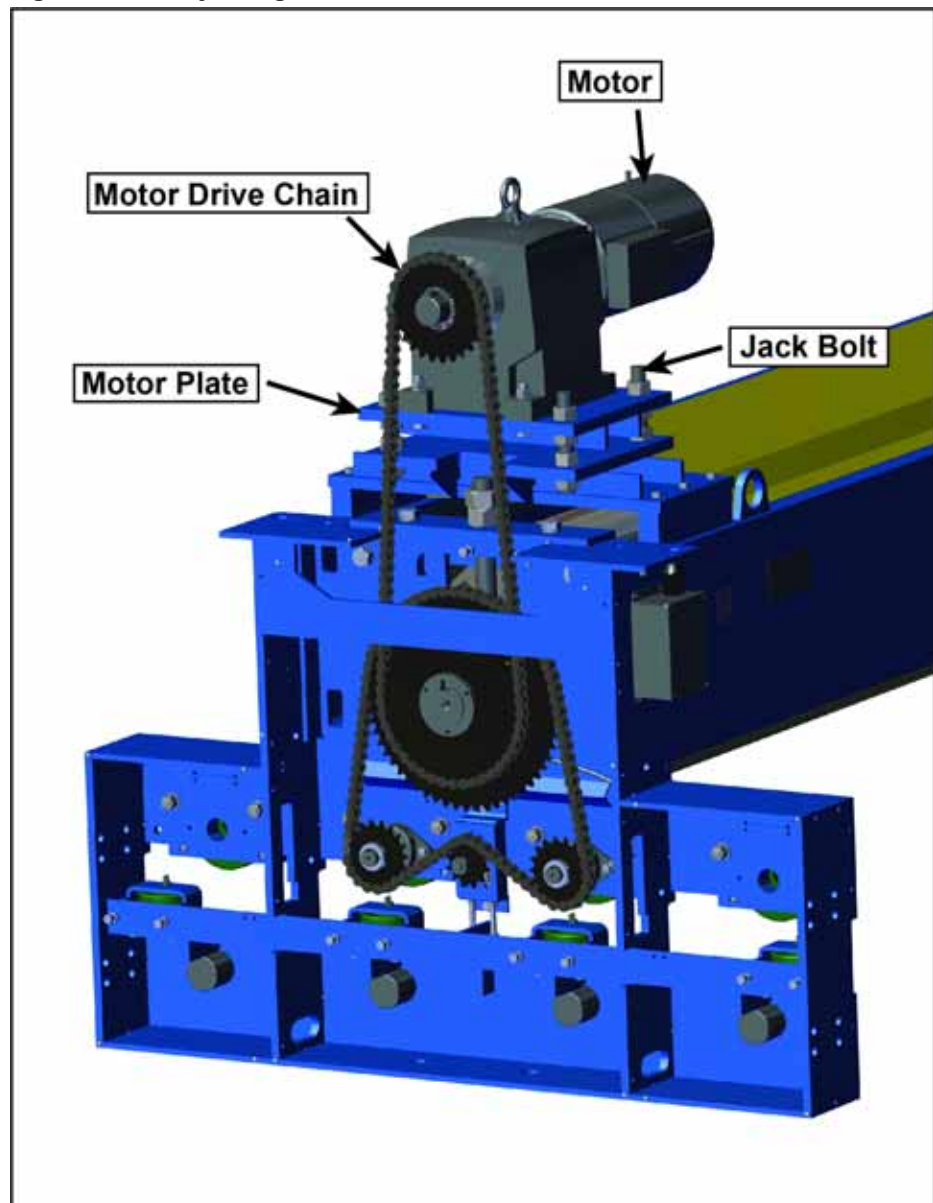

Replacing a Chain

Both of the drive wheel chains and the motor drive chain can be replaced using the following procedure. Refer to page 58 for a close-up view of the motor drive chain and page 57 for the drive wheel chain.



1. Move the gantry head to a position where the master link is clear of the sprockets so it can easily be reached. The master link is shown in Figure 6-33.
2. Lockout/tagout the machine.
3. Remove the end guard from the gantry head.
4. Note how the chain is threaded around the sprockets. It is diagrammed on page 57 and page 58.
5. Loosen the tension sprocket per the *Adjusting the Chain Tension* section.
6. Remove the master link on the chain by pulling out the two (2) pins using pliers. The chain will come apart and can be removed from the sprockets.
7. Thread the new chain around the sprockets. Refer to page 79.
8. Connect the chain to itself by placing the master link between two links and pressing together with pliers.
9. Adjust the tension sprocket so the chain has approximately 1/2 in. play (1/4 in. movement to both sides of center). Refer to the page 57 or page 58 instruction on adjusting chain tension.
10. Replace the end guard and remove the lockout/tagout equipment.

Figure 6-33: Master Link on a Chain

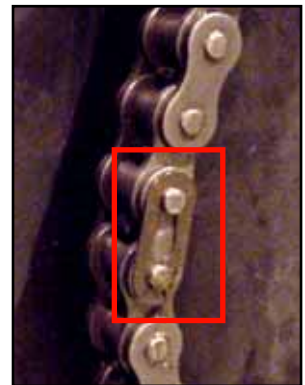

Adjusting the Roller Height

Check the roller setting with a standard 2x4 (1-1/2 in. thick) piece of lumber and 1/16" shim. The shim should slide between the bottom of the roller and the 1-1/2" thickness of the 2x4 at each end of the roller. If satisfactory plate embedment (about 80% into top and 50% into bottom of the truss) is not achieved, repeat with only the 2x4 lumber.

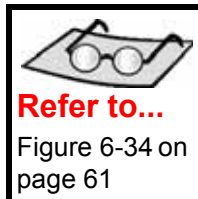

1. Place a truss on the table and move the gantry head over the truss. Stop the machine while the head is on the truss. Lockout/tagout all power to the machine.
2. Remove the guard or guards from one end of the gantry head to access the take-up bearing.
3. Loosen the locking bolt.
4. Loosen the locking nut.
5. Loosen the adjusting nut to make room for adjustment.
6. Back out the bottom nut located behind the hanger bracket. This nut should be loose enough to back-out by hand.
7. Go the other side of the gantry head and repeat step 2 through step 5 there.
8. Tighten or loosen the adjusting nut. Alternate between ends of the gantry head, turning each adjusting nut several turns at a time. Slide a piece of 2x4 lumber under the ends of the roller to check the desired height.
9. After the roller has reached the desired height, hand-tighten the bottom nut until it is touching the hanger bracket.
10. Tighten the adjusting nut with a wrench until it is snug.
11. Tighten the locking nut against the adjusting nut to hold it in place.
12. Replace the guards and remove the lock and tags. Restore power and resume operation.

Figure 6-34: Take-Up Bearing Adjustment

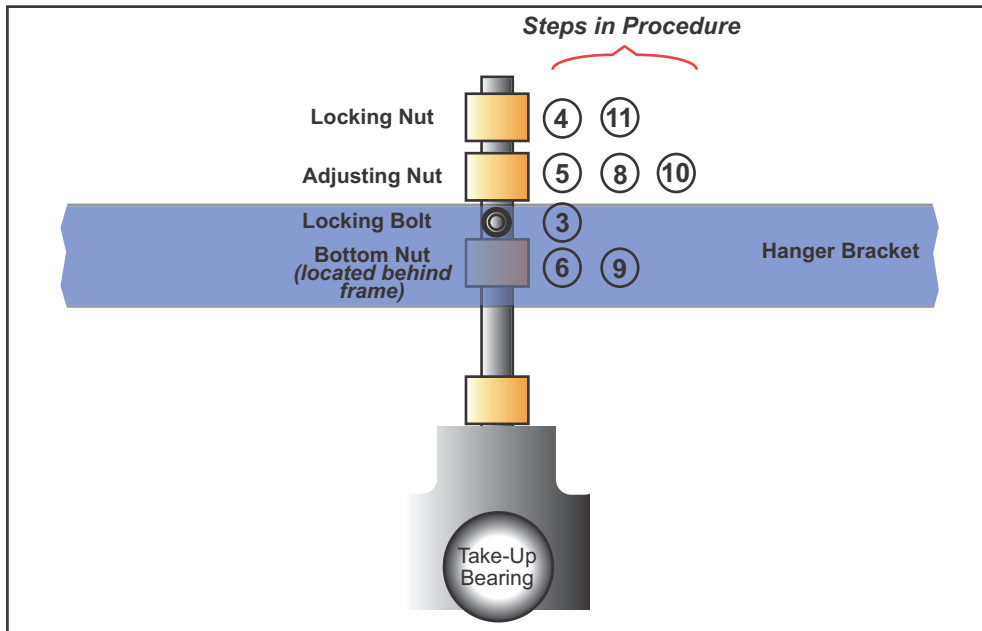

Joystick

Lubricate the joystick once every 12 months (one shift) or 6 months (2 shifts). A light grease should be applied to active components, such as spring return arms, yokes, gear drives, and detent rollers. Periodically inspect the assembly for torn or damaged boots and loose screws/bolts. Replace or tighten them immediately.

Safety Controller

This information applies to the safety controller used in 2016. It can also be found in the Omron catalog number Z922-E1-01. This section contains text protected by Omron copyrights.

The safety controller ensures that all safety features on this machine are working properly. The safety controller is located in the main electrical enclosure, shown in Figure 6-35.

Inspecting the Safety Controller

Perform the inspection that is included in the Weekly Checklist on page 107. Any inspection task that is not within acceptable limits should be fixed immediately.

Figure 6-35: Safety Controller, Inside Main Electrical Enclosure



Safety Controller Operating States

The indicator lights on the front of the safety controller show which Operating Mode the safety controller is in. Additional diagnostics are described on page 90 in the *Troubleshooting* appendix.

Table 6-3: Operating Modes for the Laser Scanner System

Operating Mode	Description	MS Indicator	MC Indicator
Run mode	All functions are supported, including the program	Lit green	Off
Idle mode	Initialization has been completed. The safety controller is waiting to move to Run Mode.	Lit green	Off
Configuring mode	Waiting for the configuration to be downloaded	Flashing green/red	Off
Abort mode	<p>Minor error occurred:</p> <ul style="list-style-type: none"> An unsupported Expansion I/O Unit is connected More than two Expansion I/O Units are connected An unsupported Option Board is connected <p>Cycle the power supply, or reset from the safety controller configurator to return to Run mode.</p>	Flashing red	Off
Memory Cassette mode	Data is being backed up or restored to/from a memory cassette.	Off	Flashing or lit yellow
Critical Error (system fail)	A critical error has occurred. All operation stops, and safety controller enters the safe state.	Lit red	Off
Initialization	Self-diagnosis is being performed.	Flashing green/red	Off

VFD and Encoder

The VFD (Variable Frequency Drive) is located in the main electrical enclosure. The VFD controls the speed that the gantry head travels and stops. A built-in PLC allows the VFD to monitor the drive chain's motion during braking and alerts the operator when the gantry is not stopping as expected.

Broken Chain or Faulty Encoder

When a chain breaks or the encoder does not register chain movement, the operator control station sends a message to the VFD that the gantry head should be moving, but the encoder sends a message to the VFD that the gantry head is not moving.

- Refer to page 59 to replace a chain.
- Refer to page 87 to troubleshoot the electrical system.

If the encoder is not sending a message at all, it may be a faulty encoder or loose connection.

Managing Voltage Drops

The VFD monitors the power supply voltage to ensure safe operation. If a voltage over the upper limit or under the lower limit is detected, the VFD has a fault and stops operation.

If the VFD experiences a fault due to a voltage drop, try pressing the Reset button to clear the fault. If pressing Reset does not clear the fault, call customer service.

Laser Scanner

The *RoofTracker III* has a pair of scanners. They are used to detect obstructions. When the scanner senses an obstruction in its safety zone, the E-stop circuit causes the gantry head to stop moving. Red lights appear on the scanner in whatever directions in which an obstruction exists.

Figure 6-36: Laser Scanner Detecting an Obstruction



Maintaining the Laser Scanner



Cleaning

The laser scanner requires periodic cleaning of the scan window and dust detection surface on the base of the window. The interval of the cleanings will depend on the environment in which it is used.

It is recommended that the window be cleaned using a common glass/plastic cleaner. The window should be sprayed and wiped down with a soft cloth to prevent damage to the surface. Do NOT use benzene, acetone, or a thinner as it will damage the surface.

Maintaining Stability

Check the tightness of the laser scanner's mount every 6 months (one shift) or 3 months (two shifts) for unnecessary vibration. Extreme vibration could cause the scanner to detect an obstruction that does not exist.

 WARNING	
	<p>Never adjust the angle or location of the laser scanner.</p> <p>If the laser scanner's mount becomes bent or damaged, it must be fixed before operating the machine.</p>

Laser Scanner Components

Figure 6-37: Laser Scanner Components

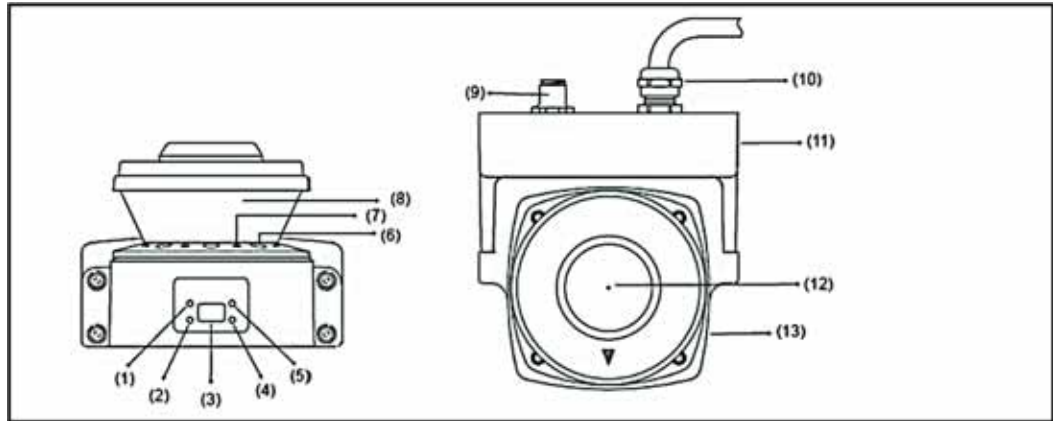

Table 6-4: Laser Scanner Components Defined

1	RUN indicator (green)	Will turn ON when safety zone is clear and OSSDs are ON
2	Interlock Indicator (yellow)	Will turn ON when in interlock state, blink under lockout, and blink in case of a failure
3	Status/Diagnostic Display	The scanner's status, configuration/operation, or failure is displayed
4	Warning Output Indicator (orange)	Will illuminate when an obstruction is detected in the warning zone
5	STOP indicator (red)	Will illuminate when safety zone is blocked, OSSD are OFF or under interlock state
6	Dust Ring	Dust detection cover with reflective surface, for dust accumulation detection
7	Individual Sector Indicators	Will turn ON when intrusion is detected in the safety zone, 8 sectors total. 1 sector =33.75°
8	Scan Window	The window where the laser light is emitted and received
9	Communication Connector	Provides for Ethernet interface
10	Power Connector	For power connections, 18-pin connector (pigtail)
11	I/O Block	Connector module
12	Center of rotation	Indicates the location of the axis around which the laser irradiates from
13	Sensor	Sensor head; field replaceable

Operating States of Laser Scanner

Operating Mode

After powering on, the laser scanner enters the interlock state if no fault or obstruction is detected within the safety zone. Press the Reset button on the operator station to release the interlock state and enter the run (ON) state. If an object enters the safety zone, the scanner will stop the gantry head. During this stage, it is capable of moving in the opposite direction. Once the safety zone is clear, the sensor will enter the interlock state, and the Reset button must be pressed before the gantry head will begin motion in the same direction it was going when the fault occurred.



See page 97 for diagnostic codes.

Indicators Lights

Table 6-5 describes the indicators on the scanner assembly. Knowing what these indicators are communicating to the operator assists in quick troubleshooting efforts. For more troubleshooting guidance, refer to the *Troubleshooting* appendix starting on page 97.

Table 6-5: Indicators on Laser Scanner

Indicator Name	Color of LED	Status	Definition
RUN indicator	Green	On	Signal switch is ON
		Off	Signal switch is OFF
STOP indicator	Red	On	Signal switch is OFF
		Off	Signal switch is ON
Interlock indicator	Yellow	On	Interlock state (need to press RESET on operator station)
		Flashing	Lockout state (@ 1Hz) Configuration state (@ 4 Hz)
Warning output indicator	Orange	On	When any warning zone is intruded
		Flashing	Dust is detected on scan window
		Off	No warning present
Status/Diagnostic display		□□	
Individual sector indicators	Red	On	Shows which zone is intruded (only 1 zone is used)
		Flashing	Dust is on scan window
		Off	Zones are clear and window is clean



Refer to page 67 for location of scanner parts.

See page 97 for diagnostic codes.

See page 87 for troubleshooting guidance.

Table 6-6: Operating States for the Laser Scanner

State	Description
On	The two safety outputs are in the ON state, and the machine run (green) indicator is lit. The protected machine is allowed to operate. The state/diagnostic display indicates a state of monitoring zone set selection and a response time.
Off	An object exists in a safety zone and it is being detected. The two safety outputs are in the OFF state, and the machine stop (red) indicator and the intrusion indicators in the affected region(s) are lit. The protected machine is not allowed to operate. The status/diagnostic display shows "- -".
Interlock	This state waits for a start input. The two safety outputs are in the OFF state, the red STOP indicator and yellow interlock indicator are lit. The protected machine is not allowed to operate. The status/diagnostic display shows "01".
Lockout	A failure is being detected and the guarded machine is being stopped. The two safety outputs are in the OFF state, the machine stop (red) indicator is lit and yellow interlock indicator is flashing. The protected machine is not allowed to operate. The status/diagnostic display shows the error code that caused the lockout. The system will remain in the lockout state until the problem is corrected and a start input is applied or power on the unit is cycled.

Scanning Regions and Scanner Limitations

The boundaries of the scanned safety zone are configured by MiTek as shown in Figure 6-38.

Keep the following points in mind when operating and maintaining the laser scanner:

- The laser scanner scans on both sides of the gantry head. If it detects a distant obstruction, the scanner slows the gantry head. If it detects a nearby obstruction, the scanner triggers an E-stop.
- Scanning region (also called the safety zone) should not be within 100 mm of a wall or fixed object.
- The scanner transmission can interfere with personal radio reception.
- Extreme vibration can cause the laser scanner to register an intrusion.
- It is possible for ambient light to interfere with normal operation of the laser scanner. Ambient light is the light from the surrounding environment: overhead lights, sunlights, etc.
- Light interference DOES NOT lead to a loss of safety. It may, however, cause false emergency stops of the guarded equipment.



	 WARNING
	<p>Never adjust the angle or location of the laser scanner.</p> <p>If the laser scanner's mount becomes bent or damaged, it must be fixed before operating the machine.</p>

Figure 6-38: Safety Zone Scanned by Laser Scanner



Zones above are intended as representations. Actual dimensions of zones may change.

Figure 6-39: Safety Zone Scanned by Laser Scanner

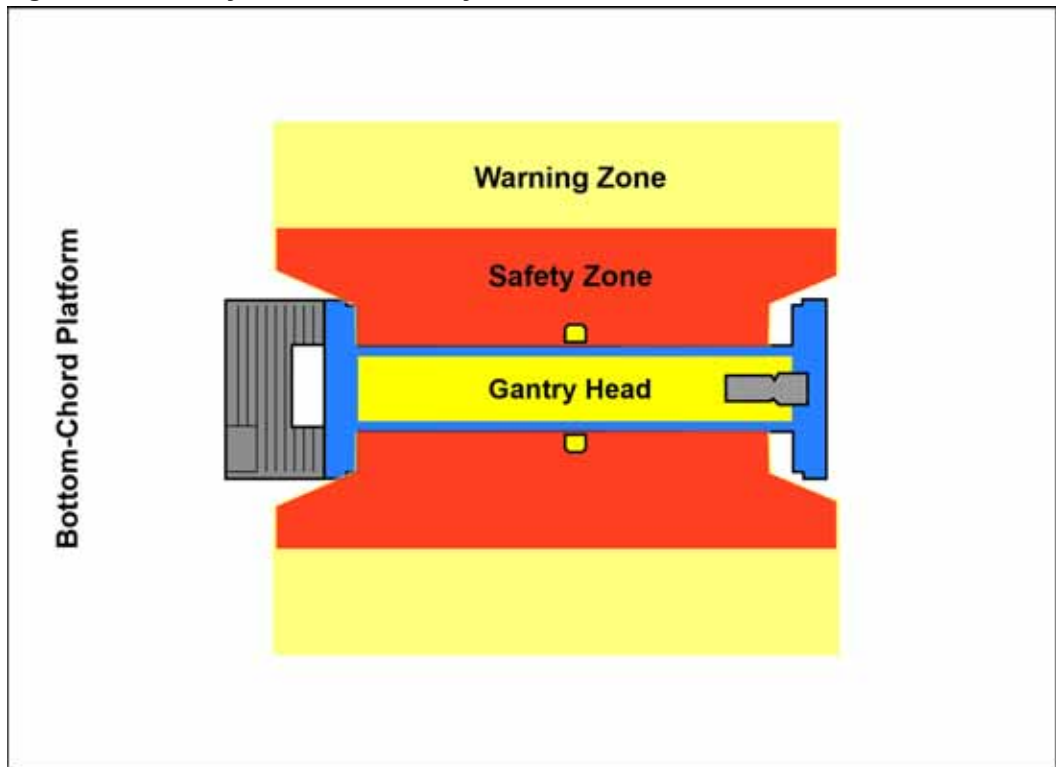
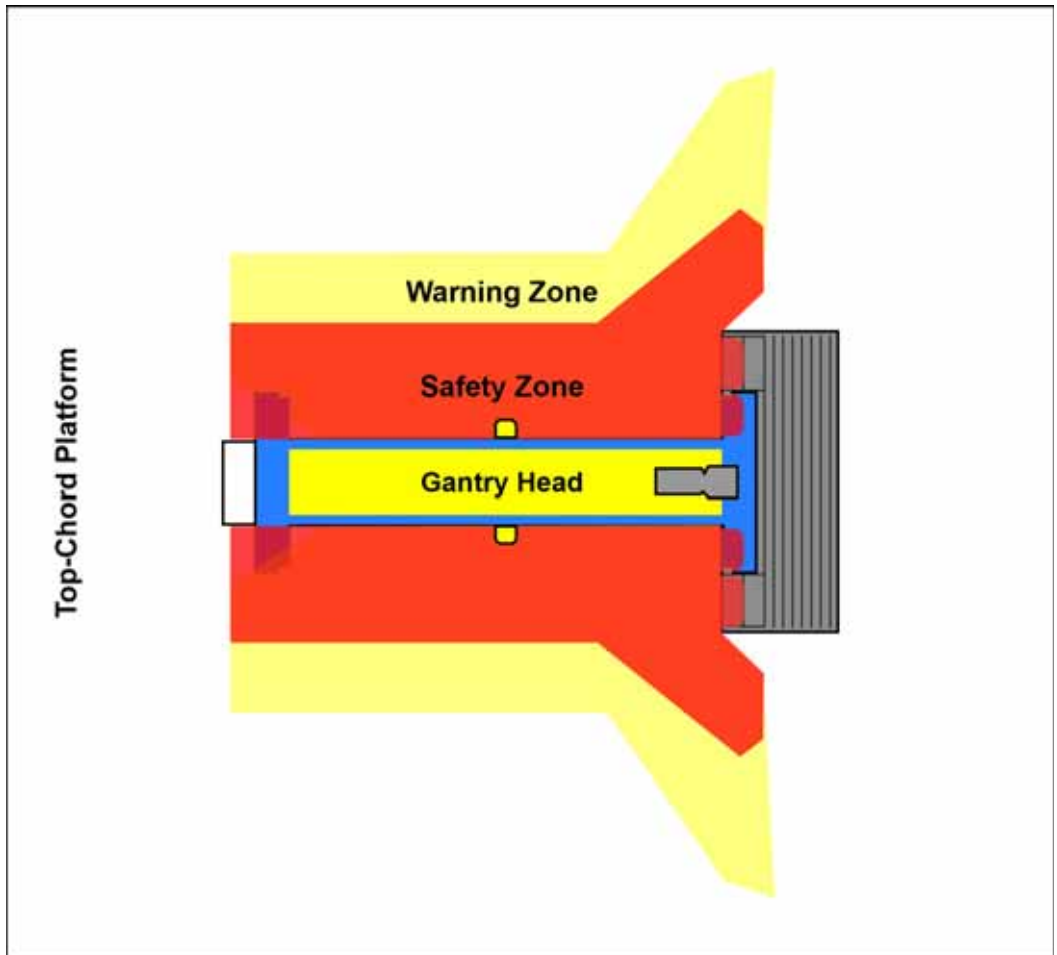

Zones above are intended as representations. Actual dimensions of zones may change.

Replacing the Scan Window

If the scan window of the laser scanner gets scratched or damaged, it must be replaced to prevent faulty trips. Contact Machinery Division Customer Service for the scan window part number and for placing an order.



1. Wipe off dirt and dust from the laser scanner and surrounding area.
2. Remove the 4 screws and washers on the sides of the window. Set aside for later use.
3. Gently pry up on the window edge to remove the window.

NOTICE



Do not allow dirt to fall into the laser scanner when the electrical components are exposed.

Never use industrial compressed air to clean electrical components.



Tighten the screws to approximately 5.0 in.-lb.

4. Locate the new window and verify that the gasket is seated properly.
5. Set the new window in place, with the arrow on top pointing toward the front of the scanner.
6. Reinstall the 4 screws and washers, gently tightening them in an alternating pattern. Do not over-tighten, or the window will crack!
7. Clean the window thoroughly using a soft cloth and common glass cleaner.
8. After cleaning, inspect the scanner and tables using the following steps.
 - a) Verify that all fingerprints and dust have been cleaned from the window.
 - b) Verify that dirt did not fall into the scanner when it was open.
 - c) Verify there are no obstructions (such as tools left out) in the scanner's zone.
9. Restore power to the scanner and perform the safety test on page xviii.

If the scanner still does not function, replacement of the entire scanner may be necessary. Call the MiTek Machinery Customer Service Department at 800-523-3380.

Indicator Lights and Sounding Device



For more information on the beacon and horn, see page 20.

Beacon

The exterior of the lens on the beacon should be cleaned when dirt starts to dim the light. Make sure the power to the machine is off. Clean the lens with a clean soft cloth using water and a mild detergent.

Refer to the *Replacement Parts* appendix on page 101 for a part number if you need to replace the beacon.



The colors displayed by the light are explained on page 20 in the *Operation* chapter.

Figure 6-40: Beacon and Horn



Horn

The horn is located on the underside of the main electrical enclosure. For safety reasons, the horn must be kept in working order. To replace the horn, refer to your electrical drawing for part numbers and an electrical schematic.

	 DANGER
	<p>Do NOT attempt to change the time delay between the horn and movement or the volume of the horn. Without these safety features, serious injury or death could occur.</p>

Graphics

General Graphics

Figure 6-41: Electrical Enclosure and Safety Features, Operator End of Gantry

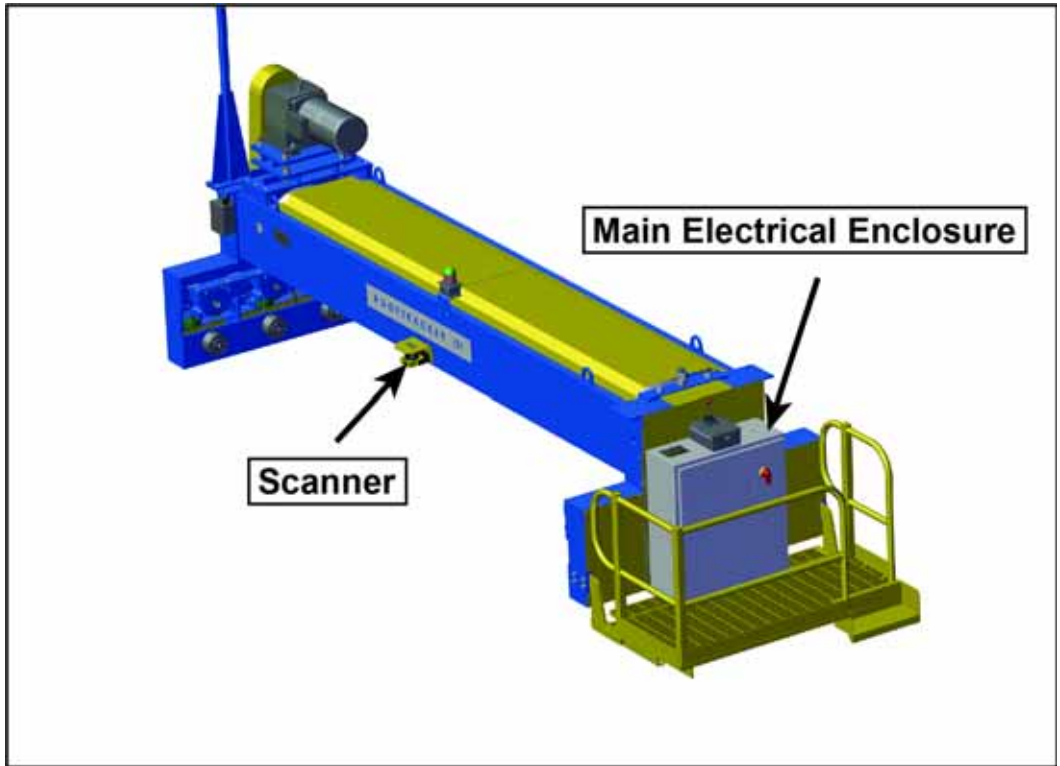

Drive System and Wheels

Figure 6-42: Drive System on Outer Side of Gantry Head

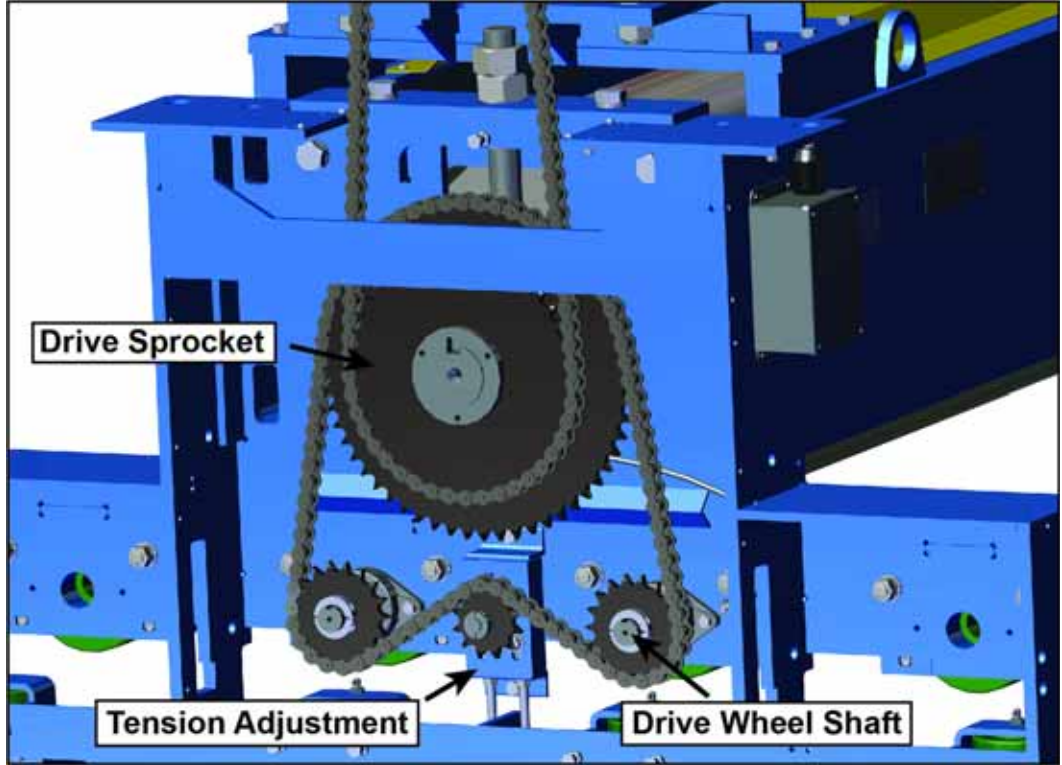
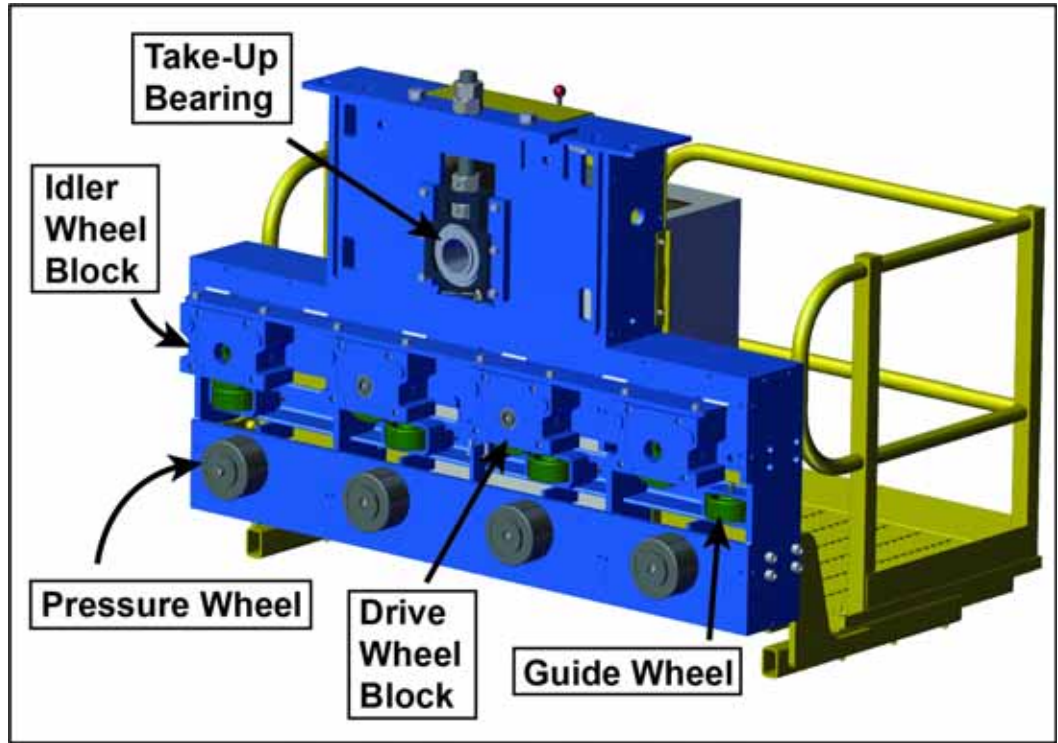

Figure 6-43: Wheel Locations on Inner Side of Gantry Head



Lubrication Graphics

Figure 6-44: Chain Lubrication Points

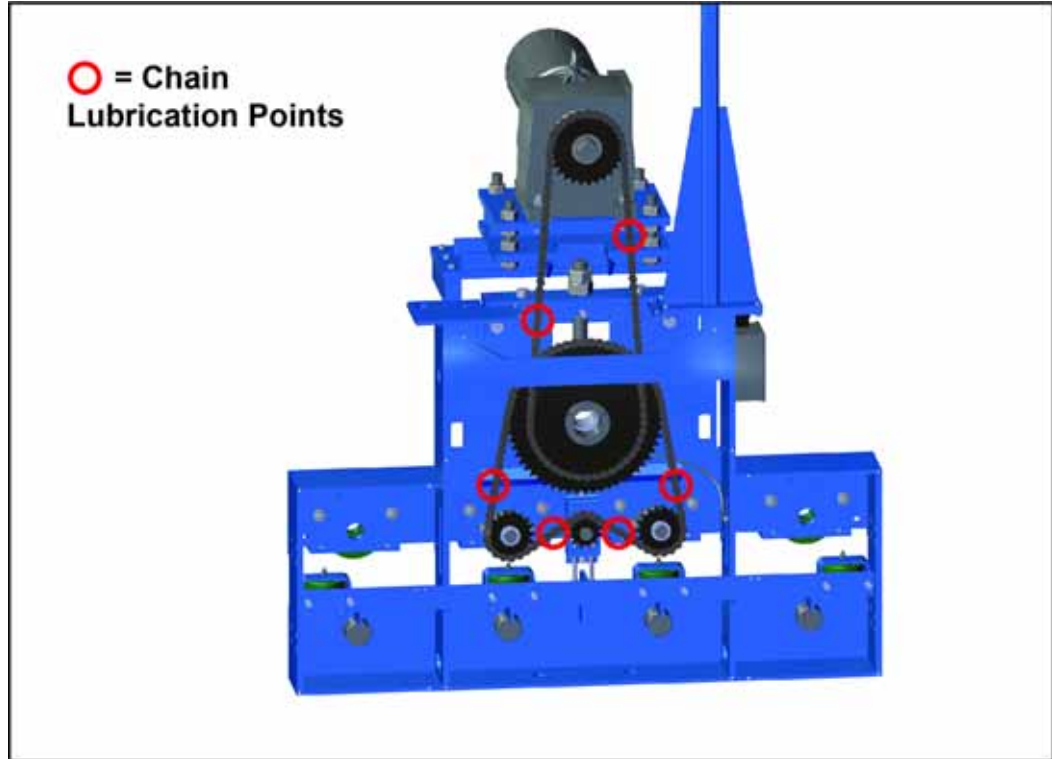
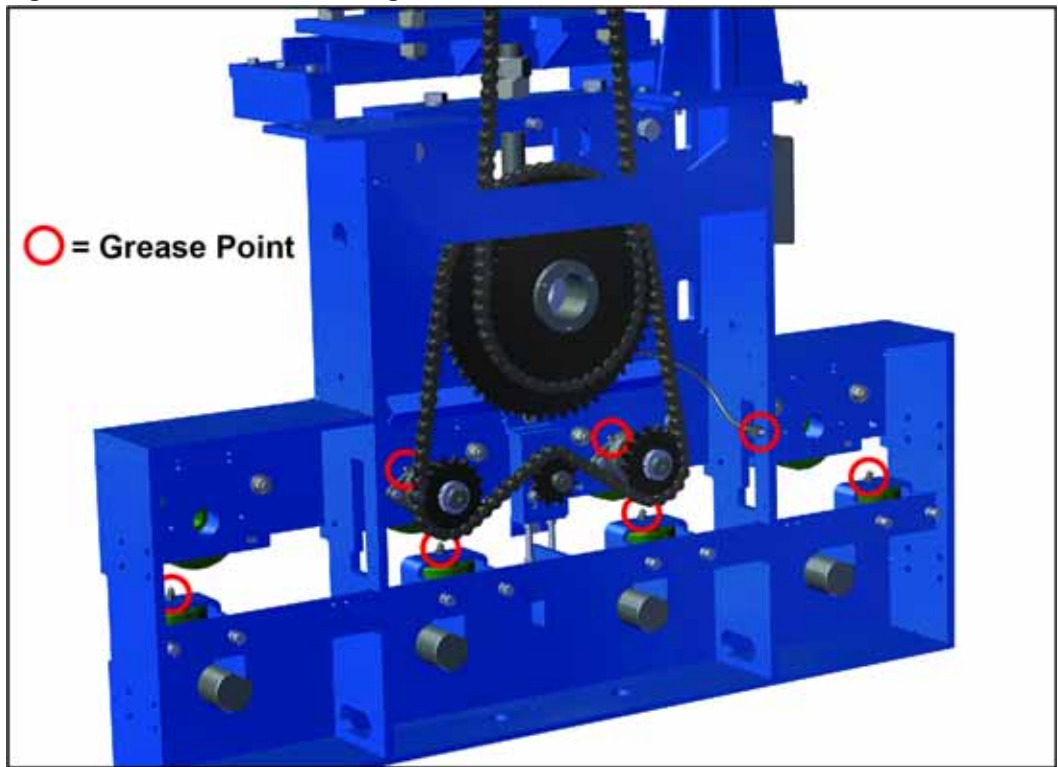

Figure 6-45: Wheel and Bearing Lubrication Points



Note: grease points for the drive wheel shafts are located on the inner side of the gantry head.

See page 108 for the frequency of applying grease

Navigating the Troubleshooting Appendix



This appendix is divided into tables according to the system or components that are not working properly. The tables are presented in the order listed here.

Table Number	Trouble Topic	Page
Table A-1	Troubleshooting the mechanical system	Page 85
Table A-2	Troubleshooting the electrical system	Page 87
Table A-4	Safety controller diagnostics and troubleshooting	Page 90
Table A-5	Laser scanner diagnostic codes	Page 97

If you continue to have problems after performing all applicable troubleshooting steps and reviewing the topic in the *Maintenance* chapter, call MiTek Machinery Division Customer Service for assistance.

Safety Notes for Troubleshooting

General Troubleshooting Safety Tips

	 WARNING
	<p>ELECTROCUTION AND CRUSH HAZARDS!</p> <p>Read all notes in this section AND the safety section in the preliminary pages before operating or maintaining this equipment.</p> <p>Most solutions are described in more detail in the <i>Maintenance</i> chapter and may have more safety notes included there.</p>



- **Read all warnings** located in the safety section in the preliminary pages and adhere to them at all times.
- **When the graphic at left appears, lockout/tagout at the disconnect switch located on the equipment** using approved methods described in OSHA 29 CFR 1910.147 before continuing with the procedure or troubleshooting.
- If the lockout/tagout graphic does not appear, it is recommended that you still **de-energize the machine** unless energy is required for the troubleshooting process. If it is absolutely necessary to troubleshoot an energized machine, follow NFPA 70E for proper procedures and personal protective equipment.
- **All electrical work must be performed by a licensed electrician.**
- **Read this manual** for information and procedures related to the specific maintenance or troubleshooting issue before attempting any maintenance!
- **Safety goggles and a dust mask** must be worn for all cleaning steps outlined in this manual. When using cleaning and lubrication solutions, a respirator rated for use with those solutions must be worn as well as gloves resistant to the solution.

Electrical Troubleshooting Safety Tips

- **Make sure you have the proper tools needed for the job.** Some tools recommended for troubleshooting are listed on page 83.
- **Ensure the person performing the troubleshooting is qualified** from an electrical knowledge standpoint. If you feel uncertain about troubleshooting electrical power, remember, the cost of hiring an electrician far outweighs the cost of an injury.
- **Remove rings and watches that you are wearing.** They are extremely conductive material and may catch on small components.
- **Get a helper.** You are most likely going to need a third hand at some point, and you shouldn't perform electrical work without someone close by to help if you get hurt.
- **Be patient.** Take your time and stay alert. Never shortcut or become too confident in what you are doing; electrical power will always be stronger than you.
- **Take notes** recording what you have checked, and what the readings were. This is also a good way to check your work when you are finished. Sometimes, the machine won't work because a wire was removed for testing, and overlooked when cleaning up. Having proper notes will make the process go much more smoothly.
- **ALWAYS turn the power off** if you are checking for ohms or swapping PLC cards.
- **ALWAYS push an E-stop button** before approaching a machine for any reason, but if you are working with the encoders it is especially important. An interruption to a powered encoder may cause components to move without warning.
- **Wear appropriate personal protective equipment (PPE)** for working with live power.

Getting Started With Troubleshooting

Tools Needed

Gather these tools before beginning the troubleshooting process and before calling MiTek for technical assistance.

1. Slotted screwdriver, insulated
2. Phillips screwdriver, insulated
3. Equipment manual and drawings, specifically electrical schematics
4. Pen and paper to take notes and document settings
5. Multimeter

A multimeter is an electronic measuring instrument. The analog versions were referred to as an analog volt-ohm-meter (VOM). A newer, digital model is called a digital-multi-meter (DMM). There are a large variety of volt-measuring devices available, but at a minimum, it should have these features:

- Voltage (volts) measurement
 - Resistance (ohms) measurement
 - Ability to measure both AC and DC power
 - Autoranging feature
 - It is highly beneficial to also have the ability to measure current (amps)
6. Various additional tools depending on which parts are in question
 7. Personal protective equipment as dictated by NFPA 70e

The First Steps

For Mechanical Troubleshooting



Lockout/tagout the gantry head. Always clean and lubricate the equipment as a first step in mechanical troubleshooting processes. Most mechanical malfunctions are caused by inadequate preventive maintenance.

For Electrical Troubleshooting



1. Lockout/tagout at the disconnect switch located on the equipment.

	<p>Never use compressed air inside the electrical enclosures! It may force contaminants into the electrical connections.</p> <p>Use a vacuum to remove dust from electrical enclosures. Canned air is acceptable after vacuuming.</p>
---	---

2. Vacuum and dust the electrical enclosure.
3. Remove the lockout/tagout equipment and attempt to run the machine again. If cleaning did not fix the problem, proceed with the next step.
4. Adhere to all regulations and guidelines given in NFPA 70e and in your company's energy control program. Some important safety tips are also addressed on page 81.

	<p style="text-align: center;">⚠ WARNING</p> <p>ELECTROCUTION HAZARD!</p> <p>All electrical work must be performed by a licensed electrician.</p> <p>If it is absolutely necessary to troubleshoot an energized machine, follow appropriate guidelines.</p>
--	---

5. Determine where the electrical problem begins. To do this, you need a multimeter. If you are unfamiliar with your multimeter, consult the manufacturer's manual.
 - Determine if you are working with AC (alternating current) or DC (direct current) before checking for voltage. Your multimeter should measure both, but you'll have to tell it which one to measure.
 - Measure incoming and outgoing voltage to specific components. Proceed along a logical order determined by your machine's specific problem, and write down the order that you check each item and the amount of voltage that it registers.



Should you lockout/tagout to safely perform this action?



Mechanical Troubleshooting

Table A-1: Troubleshooting the Mechanical System

Problem	Possible Cause	Possible Solution	See Page
Gantry head won't move at all (Refer to Table A-2 for electrical problems.)	Motor drive chain loose or broken	Adjust the tension or replace chain	56 58
	Drive wheel chain loose or broken	Adjust the tension or replace chain	56 58
	Gantry head or a wheel is jammed with a foreign object	Check the perimeter of the gantry head and around each wheel for blockage	
	One or more of the drive wheels are not riding on table tube	Check both drive wheels and both idler wheels for wear. Less worn wheels may prevent worn wheels from making contact. Replace worn wheels. It is recommended to replace all four wheels at the same time. Check alignment of tables	49
	Brake motor is damaged	Repair or replace brake motor	43
	Scanner detecting an obstruction in the opposite direction	Hold the Reset button while moving the gantry head away from the obstruction	21
Gantry head is tracking crookedly or uneven	Guide wheel is damaged or low on lubricant	Grease guide wheels Replace guide wheel	53
	Drive wheel is damaged or low on lubricant	Grease drive wheels Replace drive wheel	53
	Tables out of alignment	Align tables	
	Tables damaged	Replace tables	
	Drive wheel chain not tensioned properly	Adjust the tension	56
Drive gear slipping on roller shaft	Adjust the QD bushing		
Press stops slowly	Gantry is sliding to a stop	Drive wheels are worn or damaged Track tube is slippery (may be due to lubricant residue)	49
	Drive Motor Chain tension is loose	Adjust tension	57
	Drive System Chain tension is loose	Adjust tension	56
	Brake motor is worn or damaged	Check lubricants in brake motor Replace brake motor	43



Should you lockout/tagout to safely perform this action?



Table A-1: Troubleshooting the Mechanical System (Continued)

Problem	Possible Cause	Possible Solution	See Page
Nail plates are not properly embedded into the truss	Roller height is not correct	Adjust roller height with the take-up bearing	59
	Table surface is damaged	Repair tabletop	
	Tables are not level	Level tabletop according to table manual	
Nail plates are not embedded evenly	Roller height on one end differs from the opposite end	Level the roller height	59
	Table surface is damaged	Repair tabletop	
	Tables are not level	Level tabletop according to table manual	
First nail plate pressed is not embedded correctly	Pressure wheels are worn	Replace pressure wheels	54
Drive wheels or idler wheels are consistently damaged	Debris on the tube	Remove objects that were left on the table tube Clean debris occasionally If problem persists, contact customer service for a custom wiper	
Gantry head or roller is making extraordinary noise or vibration as it travels	Take-up bearing is not lubricated	Grease the take-up bearing Replace damaged take-up bearing	55
	Drive wheels, guide wheels, pressure wheels, or roller shaft may be damaged	Inspect location of noise for parts damage	
Roller is not turning smoothly	Take-up bearing is not lubricated	Grease the take-up bearing Replace damaged take-up bearing	55



Should you lockout/tagout to safely perform this action?



Electrical and Perimeter Guarding Troubleshooting



Check all bulbs on indicator lights to ensure they are still in working order before attempting to do any troubleshooting.

Table A-2: Troubleshooting the Electrical System and Perimeter Guarding

Problem	Possible Cause	Possible Solution	See Page
E-stop button is depressed, but all indicator lights are not on	Main disconnect switch is in OFF position	Switch the disconnect switch handle to On position	29
	Secondary or primary transformer fuses are open	Check primary and secondary transformer fuse	
E-stop button is released, but indicator lights are not on	Main disconnect switch is in OFF position	Switch the disconnect switch handle to On position	29
	Machine has not been started	Press and release Reset button	32
E-stop button is released, but E-stop light is on	DC output fuse is open	Check DC output fuse	
Red light on beacon blinks with RIGHT READY and LEFT READY indicator lights on	Check VFD fault code	Note fault code on VFD display (see VFD fault code). Press Reset button. If problem persists, call customer service	
Only RIGHT READY indicator light is on	An object on the left of the machine is sensed entering the warning or safety zone	Clear the zone on the left side of the machine and press and release Reset button	
Only LEFT READY indicator light is on	An object on the right of the machine is sensed entering the warning or safety zone	Clear the zone on the right side of the machine and press and release Reset button	
Joystick and button are pressed, horn keeps sounding for more than 5 seconds, and the machine is not moving	The timing relay has loose connections or is bad	Check timing relay for loose connections or replace the timing relay	
Joystick and button are pressed, horn sounds and then stops, but the machine is not moving	The control relay has loose connections or is bad	Check control relay and VFD for loose connections or replace the control relay	



Should you lockout/tagout to safely perform this action?





Table A-2: Troubleshooting the Electrical System and Perimeter Guarding (Continued)

Problem	Possible Cause	Possible Solution	See Page
Press head travels the opposite direction of the directional button pressed	The three-phase wires are connected to the wrong terminals.	Swap the wires on the contactor inside the electrical enclosure. The wires may be switched at the motor instead of on the contactor also	
Safety output OFF state while there is no intrusion by an object	Mutual interference. This may happen if light from another scanner or other type of photoelectric sensor is transmitted into the laser scanner. In such a case, install the sensor so that its scanning plane does not receive light from the other sensor.	When positioning the laser scanner downward, the laser scanner may be affected by reflection from the floor surface. Effect of reflection may increase depending on the material of the screen. Be sure to check surrounding environment before installing the scanner.	
	Incorrect monitoring zone configuration. A safety zone may have been configured too close to any objects.	Since the maximum measurement error of the laser scanner is 100mm, the safety zone must be configured at least 100mm away from any objects. Call MiTek if reconfiguration is necessary. Password is required!	
	An additional measurement error may need to be added due to reflective backgrounds.	Additional Error due to Reflective Background	
	Incorrect zone delay setting. The laser scanner will turn off if the zone set select input pattern does not fit to any of the patterns configured with the configuration tool within the configured zone delay time.	Call customer service to set the zone delay time to adjust to the specified zone set select input pattern within the given zone delay time.	
	Ambient light including high density factory lighting and strobe flash may directly affect the scanner.	Reduce ambient light.	
	Dirty environment, (e.g. fog, smoke, steam or other small flying particles) may cause the incorrect switching of a Machine Stop state.	To avoid the operation failure, keep the monitoring area clean, specifically the scan window or dust detection surface (on the base of the window).	65
	Dirty window	If the status/diagnostic display shows error code 80, clean the scan window.	65



Should you lockout/tagout to safely perform this action?

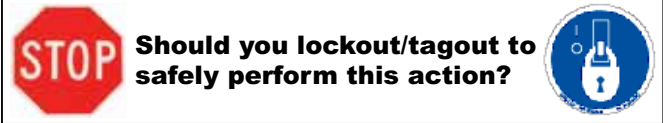

Table A-2: Troubleshooting the Electrical System and Perimeter Guarding (Continued)

Problem	Possible Cause	Possible Solution	See Page
Constant Safety Output off	Dirty window: If the status/diagnostic display shows error code 80, the scan window may be dirty or scratched.	Clean the scan window. Replace the scan window.	65
	Safety zone layout change	Verify that no objects are intruding in the configured safety zone. If the scanner is detecting something, the intrusion indicator will turn on. The configuration software can also be used to monitor the scanning information of the scanner.	



Safety Controller Diagnostics and Troubleshooting

Safety Controller Diagnostics

The indicators shown in Figure A-1, located on the front of the safety controller, communicates its status and Operating Mode.

Refer to page 62 for more information about the safety controller.

Figure A-1: Diagnostics Display for Safety Controller (from Omron Cat. No. Z922-E1-01)

MS		FORCE		LOCK	ERR/ ALM	MC	COMM	OUT PWR	I/O		Status
Green	Red	Yellow	Yellow	Red	Yellow	Yellow	Green	Yellow	Red		
Normal operating status											
⊗	●	---	⊗	●	●	---	---	---	---	---	Normal operating status after completing user testing
⊗	●	---	⊗	●	●	---	---	---	---	---	Normal operating status during user testing
Stopped but no error detected											
●	●	---	---	●	●	---	---	---	---	---	Internal power not supplied
⊗	●	---	---	●	●	---	---	---	---	---	Stopped in IDLE Mode
⊗	⊗	---	---	●	●	---	---	---	---	---	Stopped in CONFIGURATION Mode
●	●	---	---	●	⊗	---	---	---	---	---	Memory Cassette operation in progress (backup/restore)
Fatal error detected											
●	⊗	---	---	---	---	---	---	---	---	---	Critical status: System error detected
●	⊗	---	---	⊗	---	---	---	---	---	---	Abort status: Minor error detected
●	●	---	---	⊗	⊗	---	---	---	---	⊗	Error detected in Memory Cassette operation (backup/restore)
Non-fatal error detected											
---	---	---	---	⊗	---	---	---	---	---	---	Non-fatal error detected

● : Not lit ⊗ : Flashing ⊗ : Lit --- : Not relevant



Should you lockout/tagout to safely perform this action?



Table A-3: Diagnostic Definitions for Safety Controller (Use With Figure A-1)

Row	Problem	Status	Possible Solution
1	Normal operating status after completing user testing	Normal operating status	User testing has been completed, and normal operation is being performed in automatic operating mode. No particular measures are required.
2	Normal operating status during user testing	Normal operating status	User testing has not been completed, and so operation is being performed with the configuration unlocked. The present operation is normal, but the system will start in Idle Mode at the next startup. Change the operating mode from the safety controller Configurator at every startup until user testing has been completed.
3	Internal power not supplied	Stopped, but no error detected	<p>Check the following before supplying the rated power:</p> <ul style="list-style-type: none"> Is the power supply voltage within the specifications? Is the wiring correct or connected properly? <p>The unit may have failed if the measured voltage at terminal V1/G1 is normal. In that case, replace the unit.</p>
4	Stopped in Idle Mode	Stopped, but no error detected	<ol style="list-style-type: none"> 1. If the system starts in Idle Mode when it was previously operated in Run Mode, see the manufacturer’s manual for the safety controller. 2. The mode will change from Run Mode to Idle Mode when the Force Mode times out. Take suitable measures, such as starting Force Mode again.
5	Stopped in Configuration Mode	Stopped, but no error detected	Configuration data has not been downloaded to the safety controller.
6	Memory cassette operation in progress (backup/restore)	Stopped, but no error detected	<p>The safety controller will start by performing a Memory Cassette operation if it is started under any of the following conditions. This is normal, and the safety controller will resume normal operation when it completes.</p> <ul style="list-style-type: none"> The safety controller is in default status (i.e., waiting for configuration) and a memory cassette is inserted—wait until it is complete. The data stored on the inserted memory cassette is different from the configuration data in the safety controller—perform a data restore (call customer service). DIP switch pin 4 is ON.
7	Critical status: System error detected	Fatal error detected	A fatal error has occurred (e.g., hardware failure or assert error). If this occurs again after the power supply is cycled, hardware failure is probable. Replace the safety controller.



Should you lockout/tagout to safely perform this action?



Table A-3: Diagnostic Definitions for Safety Controller (Use With Figure A-1)

Row	Problem	Status	Possible Solution
8	Abort status: Minor error detected	Fatal error detected	<p>A minor error (e.g., unsupported unit mounted) from which recovery is possible has occurred. Check the following, confirm proper system configuration, and then cycle the power supply.</p> <ol style="list-style-type: none"> 1. Is an unsupported Expansion I/O unit mounted? 2. Are three or more Expansion I/O units mounted? 3. Is an unsupported Option Board mounted? (In particular, only unit version 2.0 or later of the CP1W-CIF41 Ethernet Option Board is supported.)
9	Error detected in memory cassette operation (backup/restore)	Fatal error detected	An error has been detected in a backup or restore operation using the memory cassette. See page 93 to clear error.
10	Non-fatal error detected	Non-fatal error detected	An error has been detected, but operation can continue.



Should you lockout/tagout to safely perform this action?



Safety Controller Error Names and Solutions

More information on the safety controller can be found in the Maintenance chapter, starting on page 62.

Table A-4: Troubleshooting the Safety Controller

Error Name	Possible Cause	Possible Solution
System failure	A hardware error has been detected in hardware self-diagnosis. A memory error has been detected (may be a software error).	Cycle the power supply. If the error occurs again, replace the unit.
Internal NVS access error	An error has been detected when writing the internal NVS.	Cycle the power supply. If the error occurs again, replace the unit.
Unsupported expansion I/O unit	The safety controller was started with an unsupported expansion I/O unit connected.	With the power supply off, adjust the system to the proper unit configuration, then turn on the power supply.
Too many expansion I/O units	The safety controller was started with three or more expansion I/O units connected.	With the power supply off, adjust the system to the proper unit configuration, then turn on the power supply.
Unsupported option board	The safety controller was started with an unsupported option board mounted.	With the power supply off, adjust the system to the proper unit configuration, then turn on the power supply.
Force Mode timeout	The Force Mode has timed out and program execution has stopped.	-



Should you lockout/tagout to safely perform this action?





Table A-4: Troubleshooting the Safety Controller (Continued)

Error Name	Possible Cause	Possible Solution
Memory cassette not inserted or incorrect memory cassette Si1 lit red	<p>Backup was started with a memory cassette not inserted securely.</p> <p>The safety controller was started in Restore Mode with a memory cassette formatted using the CP1@ or a memory cassette containing incorrectly formatted data.</p>	<p>Restoring Data:</p> <ol style="list-style-type: none"> 1. With the power supply off, insert a memory cassette securely, and then turn on the power supply again. 2. With the power supply off, insert the correct memory cassette, and then turn on the power supply again. <p>If the error occurs again after this measure is taken, replace the memory cassette or the safety controller.</p> <p>Not Restoring Data:</p> <p>The safety controller will attempt to restore data if it is waiting for configuration (i.e., default status) or the configuration data that is held does not match data on the memory cassette. If restoring the data is not required, remove the memory cassette and cycle the power supply.</p>
Memory cassette removed or access error Si2 lit red	<p>The memory cassette was removed during execution of a memory cassette operation.</p> <p>Hardware error in safety controller or memory cassette.</p>	<p>With the power supply off, insert the memory cassette again, and then turn on the power supply again. If the error occurs again, replace the safety controller or memory cassette.</p>
Internal NVS access error during execution of memory cassette functions Si3 lit red	<p>Controller hardware failure</p>	<p>Cycle the power supply. If the error occurs again, replace the unit.</p>
Restore model information mismatch Si4 lit red	<p>The model information in the configuration data stored on the memory cassette does not match the model information in the safety controller.</p>	<p>With the power supply off, insert the correct memory cassette, then turn on the power supply.</p>
Device password mismatch between restore memory cassette and unit Si5 lit red	<p>The device password stored in the memory cassette does not match the device password in the safety controller.</p>	<p>With the power supply off, insert the correct memory cassette, then turn on the power supply.</p>



Should you lockout/tagout to safely perform this action?





Table A-4: Troubleshooting the Safety Controller (Continued)

Error Name	Possible Cause	Possible Solution
Restore prohibit error Si6 lit red	An attempt was made to restore data to a safety controller for which restore prohibition has been set.	Using the safety controller Configurator, 1) overwrite the configuration data or 2) reset to the default settings, and then insert the memory cassette again and cycle the power supply.
Incorrect configuration data at restore Si7 lit red	Incorrect data was detected when checking the configuration data stored in the memory cassette.	With the power supply off, insert the correct memory cassette, then turn on the power supply.
Unconfigured unit at backup Si8 lit red	The safety controller contains no configuration data, and so backup to the memory cassette cannot be performed.	-
Unlocked unit at backup error Si9 lit red	The safety controller's configuration data is not locked, and so backup to the memory cassette cannot be performed.	-
Expansion I/O unit configuration mismatch	The system started with a configuration different from configuration set using the safety controller Configurator.	With the power supply off, adjust the system to the proper unit configuration, and then turn on the power supply again.
Expansion I/O unit bus error	Failure occurred when refreshing the expansion I/O unit due to unit failure, improper contact, or noise interference.	With the power supply off, check the connection to the Expansion I/O unit. If the error occurs again, replace the Expansion I/O unit or take measures against noise.
Function block status error	A logic error was detected in function block execution.	Reference the safety controller's manual
Option board communications error, communications timeout	The option board became loose after startup.	With the power supply off, check the connection to the option board, then turn on the power supply.
Output PS voltage low	The correct output power is not being supplied.	Check the following before supplying the rated power.
Output PS OFF circuit error	An error has been detected in the output power supply Off test.	<ul style="list-style-type: none"> • Is the power supply voltage within the specifications? • Is the wiring correct or connected properly? <p>The unit may have failed if the measured voltage at terminal V2/G2 is normal. In that case, replace the unit.</p>



Should you lockout/tagout to safely perform this action?





Table A-4: Troubleshooting the Safety Controller (Continued)

Error Name	Possible Cause	Possible Solution
External test signal failure at safety input	Contact of input signal lines to positive side of power supply lines. Short-circuit between input signal lines.	Check the external wiring.
	Failure of externally connected device.	Replace the externally connected device.
Internal circuit error at safety input	An error was detected in the internal circuits.	Cycle the power supply. If the error occurs again replace the unit.
Discrepancy error at safety input	Input signal line ground fault or disconnection.	Check the external wiring.
	Failure of connected device.	Replace the externally connected device.
	Incorrect set value for discrepancy time.	Review the discrepancy time.
Overload detected at test output	Output signal line ground fault.	Check the external wiring.
	Failure at externally connected device.	Replace the externally connected device
Stuck-at-high detected at test output	Contact made from output signal lines to positive side of power supply lines.	Check the external wiring.
	Internal circuit failure.	Cycle the power supply. If the error occurs again, replace the unit.
Undercut detected using muting lamp	Output signal line is disconnected.	Check the external wiring.
	Externally connected device failed.	Replace the device.
Internal circuit error at test output	An error was detected in the internal circuits.	Cycle the power supply. If the error occurs again, replace the unit.
Overcurrent detected at safety output	Externally connected device failed.	Replace the device.
Short-circuit detected at safety output	A fault in output signal lines was detected.	Check the external wiring.
Stuck-at-high detected at safety output	Contact made from output signal lines to positive side of power supply lines.	Check the external wiring.
	Internal circuit failure.	Cycle the power supply. If the error occurs again, replace the unit.
	Output power supply is outside of specifications.	Check the output power supply.
Internal circuit error at safety output	an error was detected in the internal circuits.	Cycle the power supply. If the error occurs again, replace the unit.



Should you lockout/tagout to safely perform this action?



Laser Scanner Diagnostic Codes

Table A-5: Diagnostic Codes for the Laser Scanner System

Status	Code Number	Description	Corrective Action
Normal Operation	88	Power up indication	
	--	Normal operation (guarded machine stop)	
	-- blinking slowly	Standby mode (guarded machine stop); the rate of blinking depends on mode	
	01	Interlock state (waiting for start input)	
	02	Configuration mode (guarded machine stop)	
	80	Window contamination indication (guarded machine stop)	The window is dirty or scratched; clean or replace as necessary
	70	Incorrect number of active zone set select inputs (guarded machine stop)	Check zone set select input wiring, zone configuration selection, zone set select input switching time, and zone delay configuration
	71	Invalid or undefined zone set select input combination but correct number of active zone set select inputs (guarded machine stop)	Check zone set select input wiring, zone configuration selection, zone set select input switching time, and zone delay configuration.
	□□	Call scanner manufacturer	
Safety Output Fault	30	Safety output fault	Check output connection and wiring.
	32	Safety output A is short-circuited to 24 V	
	33	Safety output B is short-circuited to 24 V	
	34	Safety output A is short-circuited to 0 V	
	35	Safety output B is short-circuited to 0 V	



Should you lockout/tagout to safely perform this action?



Table A-5: Diagnostic Codes for the Laser Scanner System (Continued)

Status	Code Number	Description	Corrective Action
External Device Monitoring Fault	40	EDM (External Device Monitoring) fault	Check output external device monitoring connection and wiring
	41	External device monitoring fault before sensor is turning on	Check that the NC-contact status of the external device is changing state before the sensor is turning on
	42	External device monitoring fault after sensor is turning on	Check that the NC-contact status of the external device is changing state after the sensor is turning on
	43	External device monitoring fault during power on	Check the output configuration, connections, and wiring
Other Faults	50	Affected by noise or disturbance light or internal fault	Check the environment if any noise or disturbance light is coming in
	52-58	Possible electrical noise interference or internal fault	Check the environment for electrical noise sources or repair the unit.
	59	The unit was possible jarred or bumped	Check the environment if any jarring occurs
	60	Invalid configuration in unit	Reconfigure unit or check current configuration
	72	Incorrect number of active zones set select inputs (hard fault code after diagnostic code 70 persists for more than 10 minutes)	Check zone set select input wiring and zone configuration selection
	73	Invalid or undefined zone set select input combination, but correct number of active zone set elect inputs (hard fault code after diagnostic code 71 persists for more than 10 minutes)	Check zone set select input wiring and zone configuration selection
	74	Standby input or zone set select inputs voltage too high	Check zone set select inputs or standby input wired at more than system power (24 VDC)
	75	Scanner chassis connect to power (24 VDS)	Scanner chassis should be grounded to 0 VDC
	82	Window not detected or entire dust detection surface is dirty or blocked	Check that the window is properly mounted and clean the dust detection surface
90	Internal temperature fault	The scanner internal temperature exceeds the operating limit: add ventilation	

Navigating the Parts List Appendix

Finding the Part Number

The parts list provided here shows spare parts that should be kept in stock at all times. Use one of the methods shown in Table B-1 to locate your part number.

If you would like a complete list of replacement parts or you would like to see pictures of parts, use the electronic Parts Guide for this machine. It can also be found on our Web site.

Table B-1: How to Find Your Part Number

Using the Spare Parts List in the Manual	Using Our Web Site: www.mitek-us.com
If it is a part that you should keep in stock, it is listed in the Parts List in the manual and in the electronic Parts Guide. Locate the correct part name and description in the manual to find the part number. If you're unsure of which part you need, use the electronic Parts Guide instead to see a picture.	<ol style="list-style-type: none"> 1. Roll your cursor over <i>Machinery</i> and select <i>Parts Guides</i>. 2. Choose the Parts Guide that applies to your machine. 3. Browse through the images to find your part number.



Ordering the Parts With Your Part Number



Each column in Table B-2 describes a method for ordering parts.



Table B-2: How to Order Your Part Using the Part Number



Using E-Mail	Using the Phone
Send an e-mail to mitekparts@mii.com with all relevant information, including the part number.	Call us at 1-800-523-3380 and select the option for Parts Orders.

Safety Notes for Replacing Parts

	 WARNING
	<p>Only use the exact replacement parts that are specified by MiTek. Substitutions may harm your equipment.</p>

	 WARNING
	<p>CRUSH HAZARD!</p> <p>Perform the safety tests described on page xviii before operating the equipment at the initial startup, after performing any maintenance, and in accordance with the maintenance schedule.</p>

	 WARNING
	<p>ELECTRICAL HAZARD!</p> <p>All electrical work must be performed by a licensed electrician.</p> <p>Follow approved lockout/tagout procedures (OSHA 29 CFR 1910.147).</p>

	 WARNING
 	<p>ELECTROCUTION HAZARD!</p> <p>Always turn the power off by activating an E-stop when the equipment is not in operation.</p> <p>Always verify that all power to the machine has been turned off and follow approved lockout/tagout safety procedures (OSHA 29 CFR 1910.147) before performing any maintenance on this equipment.</p>

Part Numbers

Mechanical Part Numbers

Table B-3: Mechanical Replacement Parts

MiTek Part #	Part Description	Refer to Drawing #	Keep in Stock
554008	Drive wheel chain #80 (Quantity of 2 at 157" each)	67420-X01 67421-X01	1
554008	Motor drive chain (Quantity of 1 at 98")	67420-X01 67421-X01	1
63733-501	Drive wheel (wheel only)	67423-X01	8
580200	Guide wheel (5x2" rubber)	67423-X01	8

Electrical Part Numbers

Table B-4: Electrical Replacement Parts

MiTek Part #	Part Description	Refer to Drawing #	Keep in Stock
516382	Brake fuses (208 / 230V)	90635-502	2
516383	Brake fuses (415 / 460 / 575V)	90635-502	2
516387	Disconnect fuses (208 / 230 / 460V)	90635-502	3
516350	Disconnect fuses (415 / 575V)	90635-502	3
516389	Transformer fuses—primary side (208V)	90635-502	2
516394	Transformer fuses—primary side (230 / 415V)	90635-502	2
516388	Transformer fuses—primary side (460V)	90635-502	2
516384	Transformer fuses—primary side (575V)	90635-502	2
516387	Transformer fuses—secondary side (208 / 230 / 460V)	90635-502	1
516350	Transformer fuses—secondary side (415 / 575V)	90635-502	1
92284-508	Laser scanner (top-chord platform) (left)	90635-501	—
92284-509	Laser scanner (top-chord platform) (right)	90635-501	—
92284-510	Laser scanner (bottom-chord platform)	90635-501	—
82611	Laser scanner mount	67390-501	—
90635-504	Beacon and cable	90635-501	—
515982	G9SP safety controller	90635-502	—
515974	Memory cassette for G9SP safety controller	90635-502	—

Documentation Part Numbers

Documentation	Qty	MiTek Part Number
Manual	1	001068
Operation and Safety Labels	Table B-6 on page 103	
Electrical Safety Labels	Table B-6 on page 103	

Guards Part Numbers

The main guards are shown in Figure B-1. Drawings, referenced on page 109, provide additional views.

Figure B-1: Guards

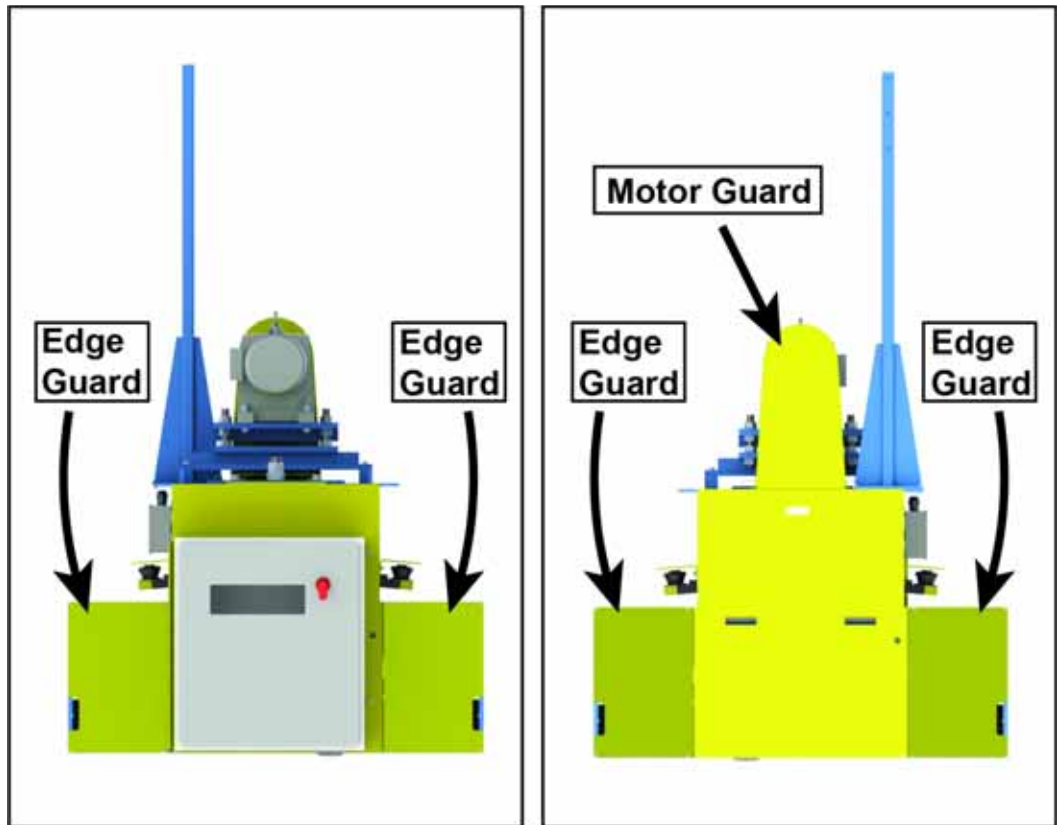

Table B-5: Guard Replacement Parts

MiTek Part #	Part Description	Refer to Drawing #	Keep in Stock
67394	Edge guard	67390-501	—
67375-501	Motor guard	67390-501	—

Labels Part Numbers

Table B-6: Labels

MiTek Part #	Part Description
691411	<p>PELIGRO Existe el peligro potencial de un arco letal y descarga eléctrica cuando trabaja es equipo energizado. Cumplir con todos los requisitos de NFPA 70E para las prácticas seguras y equipo protector personal.</p> <p>DANGER Potential arc flash and shock hazard exists while working on energized equipment. Follow all requirements in NFPA 70E for safe work practices and personal protective equipment.</p>
691507	<p>ADVERTENCIA Voltaje peligroso puede causar lesiones graves o la muerte. NO elevar ningún mantenimiento en este equipo sin primero desconectar de la fuente principal de energía. Apagar y bloquear la energía antes de realizar tareas de servicio.</p> <p>WARNING Hazardous voltage will cause severe injury or death. DO NOT perform any maintenance on this equipment without first disconnecting from main power source. Turn off and lock out power before servicing.</p>
691518	<p>ADVERTENCIA NO arrancar, operar o dar servicio a esta máquina hasta leer y comprender el Manual de operaciones y mantenimiento. El incumplimiento de las instrucciones de operación, mantenimiento y seguridad pueden resultar en la muerte o lesiones graves.</p> <p>WARNING Do NOT start, operate or service this machine until you read and understand the Operations and Maintenance Manual. Failure to follow operating, maintenance and safety instructions could result in death or serious injury.</p>
691523	<p>ADVERTENCIA Riesgo de aplastamiento. Componentes giratorios. No operar sin las defensas colocadas en su lugar. Bloquear y colocar etiquetas a la máquina antes de dar servicio.</p> <p>WARNING Crush hazard. Rotating components. Do not operate with guards removed. Lockout and tagout machine before servicing.</p>
691821	<div style="border: 1px solid black; padding: 10px;"> <p>MiTek Machinery Division Customer Service Department 301 Fountain Lakes Industrial Dr. St. Charles, MO 63301</p> <p>Parts Orders (w/part number) E-mail: mitekparts@mii.com</p> <p>Web Site www.mitek-us.com</p> <p>Technical Assistance Phone: 800-523-3380 Fax: 636-328-9218</p> </div> <p style="text-align: right; font-size: small;">691821</p>
691848	<p>It is recommended that the window be cleaned using a common Alcohol cleaner and a soft lint free cloth to prevent damage to the scan window.</p>



Maintenance Checklists

Appendix C

Navigating the Maintenance Checklists



Use the checklists in this appendix to schedule preventive maintenance. The checklists will guide you through all preventive maintenance tasks required to keep this equipment in top working condition.



These pages are supplied with the intent that you will photocopy them and document the date that maintenance is done on the copies, leaving the original in the manual for future use.

Checklist	Page
Daily Checklist	page 106
Weekly Checklist	page 107
Monthly Checklist	page 108

RoofTracker III

Safety Notes For Maintenance Checklists

	 WARNING
	<p>CRUSH HAZARD.</p> <p>Perform the safety tests starting on page xviii before operating the equipment at the initial startup, after performing any maintenance, and in accordance with the maintenance schedule.</p>



	 WARNING
	<p>ELECTROCUTION HAZARDS.</p> <p>Always turn the power off and activate an E-stop when the equipment is not in operation.</p> <p>Always verify that all power to the machine has been turned off and follow approved lockout/tagout safety procedures (OSHA 29 CFR 1910.147) before performing any maintenance on this equipment.</p>

RoofTracker III

Daily Checklist

Week of: _____

Year: _____

	 WARNING
	<p>Lockout/tagout before performing any maintenance! If power is required, ensure all personnel are clear.</p>

Action		MON	TUE	WED	THU	FRI	SAT	SUN
Perform safety test	Shift 1							
	Shift 2							
	Shift 3							
Inspect laser scanner window for dust and clean if dusty	Shift 1							
	Shift 2							
	Shift 3							

Notes



Date

RoofTracker III

Weekly Checklist

Month: _____

Year: _____



	WARNING
	<p>Lockout/tagout before performing any maintenance! If power is required, ensure all personnel are clear.</p>

Mechanical Actions	Lockout/ Tagout	Week 1	Week 2	Week 3	Week 4	Week 5
Check drive wheel chain tension—needs 1/2" play	YES					
Check motor drive chain tension—needs 1/2" play	YES					
Electrical Actions						
Check the ambient temperature inside the electrical enclosure while machine is cool (not operating): -20 to 75° C	YES					
Use a hygrometer to check the ambient humidity inside the electrical enclosure: 10% to 95% with no condensation	YES					
Check that the safety controller is not in direct sunlight	YES					
Vacuum any accumulation of dust or dirt in the electrical enclosure (do NOT use compressed air to blow dust or dirt in the electrical enclosure)	YES					
Make sure that no water, oil, or chemicals are hitting the safety controller and that no corrosive or flammable gases are in the area	YES					
Check that all terminal blocks are inserted and locked fully	YES					
Check that cable connectors are locked fully	YES					
Check for loose screws in external wiring	YES					
Use a voltage tester to check for voltage fluctuations at the power supply terminals: Must be within 20.4 to 26.4 VDC (-15% to +10%)	NO					
Check the ambient temperature inside the electrical enclosure during operation: 0 to 55 deg C	NO					

RoofTracker III

Monthly Checklist

Year: _____

	 WARNING
	<p>Lockout/tagout before performing any maintenance! If power is required, ensure all personnel are clear.</p>

Action	Months (one shift)	Months (two shifts)	Date				
Lubricate drive wheel chains	1	0.5					
Lubricate motor drive chain	1	0.5					
Check laser scanner bracket tightness	6	3					
Check brake motor air gap	6	3					
Grease take-up bearing	12	6					
Grease the drive wheel bearings (4 or 8)	12	6					
Grease drive wheel shafts (4 or 8 wheels)	12	6					
Grease the guide wheels	12	6					
Check oil level in brake motor	12	6					
Grease gantry lifter bearings (if equipped with gantry lifter)	12	6					
Lightly lubricate the joystick	12	6					
Drain and change gearbox oil	24	12					

Maintenance intervals are estimates only. Extreme conditions may require more frequent maintenance.

Notes	Date

Drawings be located in a separate binder accompanying this manual, or they may be located at the end of this manual.

Table D-1: Attached Drawings

Description	Drawing Number
Mechanical drawings	
Top-level assembly (top chord and bottom chord)	67390
Drive wheel block assembly	63735-501
Idler wheel block assembly	65571-501
Power transmission parts, left side (2WD)	67354-501
Power transmission parts, left side (4WD)	67354-601
Power transmission parts, right side (2WD)	67421-501
Power transmission parts, right side (4WD)	67421-601
Wheel installation (2WD)	67423-501
Wheel installation (4WD)	67423-601
Take-up bearing assembly	67429-501
Common parts assembly	67390-501
Bottom-chord platform assembly	67372-501
Top-chord platform assembly	67396-501
Single-head flat cable festoon	69565
Bus bar	69566
Parking stand, left hand (8')	63630-501
Parking stand, right hand (8')	63630-502
Gantry lifter	83350-501
Gantry lifter, mechanical assembly	83351-501
Electrical drawings	
Schematic	90635
Electrical assembly	90635-501
Main electrical enclosure assembly	90635-502
Joystick enclosure assembly	90635-503
Beacon assembly	90635-504
Pneumatic drawings	
Gantry lifter, pneumatic assembly	83352-501



Document Evaluation

Appendix E

A form is included in this appendix so you can provide MiTek with feedback on the usefulness of this manual. We make an ongoing effort to improve the value of our documentation, and your views are important to us.

Please follow the instructions on the form to provide us with comments or suggestions that will help us improve the quality of our documentation services.

Document Evaluation Form

We appreciate your comments on how we can make this document more useful.

Document Identification:

RoofTracker III™ Roller Press	Operation and Maintenance Manual	001068 rev. A
-------------------------------	----------------------------------	---------------

General Ratings:

	Poor	Fair	Good	Excellent
Content	<input type="checkbox"/>	<input type="checkbox"/>	<input type="checkbox"/>	<input type="checkbox"/>
Organization	<input type="checkbox"/>	<input type="checkbox"/>	<input type="checkbox"/>	<input type="checkbox"/>
Accuracy	<input type="checkbox"/>	<input type="checkbox"/>	<input type="checkbox"/>	<input type="checkbox"/>
Clarity	<input type="checkbox"/>	<input type="checkbox"/>	<input type="checkbox"/>	<input type="checkbox"/>
Completeness	<input type="checkbox"/>	<input type="checkbox"/>	<input type="checkbox"/>	<input type="checkbox"/>
Examples/Illustrations	<input type="checkbox"/>	<input type="checkbox"/>	<input type="checkbox"/>	<input type="checkbox"/>
Readability	<input type="checkbox"/>	<input type="checkbox"/>	<input type="checkbox"/>	<input type="checkbox"/>

Compared to other truss machinery manufacturers' documentation, how would you rate this document?

Poor Fair Good Excellent

There is room for specific suggestions on the next page. Document general comments here.

Document Evaluation Form (cont'd)

Identify any inaccuracies in the document.	
What are the three best features of the document?	
What are the three worst features of the document?	
What did you like/dislike about the illustrations?	
Your Name:	Date:
Company Name:	Address:
Phone:	E-mail:
Please mail this form to: MiTek Machinery Division 301 Fountain Lakes Industrial Drive St. Charles, MO 63301 Attn: Engineering Manager	Or fax this form to: 636-328-9218 Attn: Engineering Manager

If you do not receive a reply within 45 days, please call our Customer Service Department and ask for the Documentation Specialist or Engineering Manager: 800-523-3380.

Glossary

actuate	to activate, put into action
affected employee	an employee whose job requires him or her to operate or use a machine or equipment on which servicing or maintenance is being performed under lockout or tagout, or whose job requires him or her to work in an area in which such servicing or maintenance is being performed
aisle pad	a type of jiggging used when a connector plate needs to be embedded where the table surface gives way to a walk-through aisle
amperage	the strength of an electric current, expressed in amperes
anchor plate	a steel plate that holds the tables in place; it is anchored to the concrete floor and the tables are welded to it
authorized employee	a person who locks out or tags out a machine or equipment in order to service or maintain that machine or equipment; an affected employee becomes an authorized employee when that employee's duties include performing servicing or maintenance covered under this section
auto-eject	a pneumatic system that raises a truss off the tables and automatically places the truss on the stand-alone conveyors with the use of a transfer roller
beacon	a light that displays one of several colors to represent the state of the gantry head
bus bar	an electrical device that allows multiple gantry heads to be used simultaneously
connector plate	the nail-plate that is embedded into the production material to hold it together
cushion	an attribute of a hydraulic cylinder that allows adjustment of the pressure in each cylinder

Glossary

end-eject	a pneumatic system that raises the truss off the tables and allows the truss to be manually pushed or pulled off the end of the tables; this system requires that the gantry head rolls back over the truss or a device must be installed to raise the gantry head when it is parked
energized	connected to an energy source or containing residual or stored energy
energy isolating device	a mechanical device that physically prevents the transmission or release of energy, including but not limited to the following: manually operated electrical circuit breaker; a disconnect switch; a manually operated switch by which the conductors of a circuit can be disconnected from all ungrounded supply conductors, and in addition, no circuit can be operated independently; a line valve; a block; and any similar device used to block or isolate energy—push buttons, selector switches, and other control circuit type devices are not energy isolating devices
energy source	any source of electrical, mechanical, hydraulic, pneumatic, chemical, thermal, or other energy
gantry head	the entire traveling weldment that houses the Roller to embed the connector plates
inner side	refers to the end of the gantry head housing; the side closest to the tables; both ends have an inner side—one can see the inner side of both ends when standing on or between the tables
jigging	any of several devices used to hold the truss in place on the tables
laser scanner	a safety device that monitors a defined area in front of the gantry head for obstructions, slows the gantry head when it detects a distant obstruction, and triggers an E-stop when it detects a nearby obstruction
layout	a scaled diagram of the location of components and the space that they occupy

Glossary

leveling screws	large cap head screws that thread into the table legs and allow the table height to be adjusted and leveled
lockout device	a device that utilizes a positive means such as a lock, either key or combination type, to hold an energy isolating device in the safe position and prevent the energizing of a machine or equipment, including blank flanges and bolted slip blinds; should be standardized within the facility in at least one of the following criteria: color; shape; or size; and additionally, in the case of tagout devices, print and format shall be standardized
lockout/tagout	a means of isolating a piece of equipment from its energy source so maintenance can safely occur; guidelines provided in OSHA 29 CFR 1910.147
motor end	used to indicate which end of the gantry head is being discussed; the end of the gantry head that houses the motor
operator control interface	the method in which the operator controls the machine; it may be a touch screen, a control panel, etc.
outer side	refers to the end of the gantry head housing; the side farthest from the tables; both ends have an outer side
pilot valve	a pneumatic valve that operates the setup valve to control the release or cessation of air in each setup; it is located on the bottom-chord end of one table in each setup
plate	see <i>connector plate</i>
PLC	Programmable Logic Controller; a solid-state control device that can be programmed to control process or machine operations. It consists of five basic components: processor, memory, input/output module, the power supply, and the programming device.
port	a connection point for a peripheral device
potentiometer	a control knob that is a dial; allows a range of values to be set by turning the dial, commonly found on a PLC

Glossary

proximity switch	a switch that uses an electromagnetic field to detect when an object is near, there is no physical contact between the object and the switch; inductive proximity switches detect only metal objects, while capacitive proximity switches can sense both metallic and non-metallic objects
puck	a type of jigging that is small and round
qualified person	a person or persons who, by possession of a recognized degree or certificate of professional training, or who, by extensive knowledge, training, or experience, has successfully demonstrated the ability to solve problems relating to the subject matter and work—ANSI B30.2-1983; one who has skills and knowledge related to the construction and operation of the electrical equipment and installations and has received safety training on the hazards involved—NEC2002 Handbook
regulator	a component of the pneumatic system that connects to the main air source and regulates the air pressure allowed into the system
Roller	the large roller inside the gantry head that initially embeds the plates into the truss
setup valve	a component of the pneumatic system that control the flow of air to the rest of the setup
side-eject	a pneumatic system that raises the truss off the tables and allows the truss to be manually pushed or pulled off the side of the table and onto the stand-alone conveyors
slider pad	a type of jigging used when a connector plate needs to be embedded where the table surface gives way to a slot for the Ejector
solenoid	an assembly used as a switch consisting of a coil and a metal core free to slide along the coil axis under the influence of the magnetic field
stand-alone conveyor	the conveyor system that carries the truss from the tables to the Finish Roller and out to the stacker

Glossary

stop	a type of jigging that is long and straight
tagout device	a prominent warning device, such as a tag and a means of attachment, which can be securely fastened to an energy isolating device in accordance with an established procedure, to indicate that the energy isolating device and the equipment being controlled may not be operated until the tagout device is removed; should be standardized within the facility in at least one of the following criteria: color; shape; or size; and additionally, in the case of tagout devices, print and format shall be standardized
take-up bearing	adjusts the height of the roller
torque	a turning or twisting force
transfer roller	a motorized roller sitting perpendicular to the tables on an auto-eject system; it automatically transfers the truss from the Ejectors to the stand-alone conveyors
VFD	Variable Frequency Drive; controls the speed of the cycle
voltage	Equal to the difference of electric potential between two points on a conducting wire carrying a constant current of one ampere when the power between the points is one watt

Index

B

- beacon 20, 74
- bearings
 - lubrication 79
 - take-up for press roller 56
- brake
 - air gap 38, 39
 - pad replacement 37
- brake motor 29

C

- centerlines
 - terminology 11
- chains
 - adjusting tension 57, 58
 - broken chain 64
 - drive wheel 59
 - lubrication 56
 - master link 59
 - replacing 59
- checklists
 - maintenance 104
- configurations 8
- contact information 3
- control relay 87
- controls
 - joystick 21
 - reset 21
- Customer Service 3

D

- diagnostics
 - laser scanner 97
 - safety controller 90
- direction of motor *see* motor
- disconnect 19
- disconnect switch
 - switch
- document evaluation form 111
- drawing set 109
- drive fault 87
- drive system

- chain tension 57
 - graphic 76
- drive wheels
 - chains 57, 59
 - graphic 78
 - lubrication 40, 79

E

- electrical
 - checking voltage 83
 - enclosure
 - indicator lights 20, 74
- emergency stop *see* E-stop
- encoder
 - no chain movement 64
 - overview 64
- equipment configurations *see* configurations 8
- errors, *see* diagnostics
- E-stop 87

F

- faults
 - safety controller 93
- faults, *see* diagnostics
- frequency of maintenance *see* checklists

G

- gantry lifter
 - pneumatic pressure 15
- gearboxes 29
- grease
 - graphic 79
 - overview 28
- guards
 - part numbers 102
 - spare parts 102
- guide wheels
 - graphic 78
 - lubrication 52, 79
 - replacing 52

Index

H

horn 74, 87
hour-meter 75

I

idler wheels
 graphic 78
 lubrication 40
indicator lights
 general 20
 laser scanner 68
 maintenance 74
 safety controller 90
 troubleshooting 87

J

joystick 21

L

labels 103
labels *see* safety
laser scanner
 cleaning and maintaining 65
 components 67
 diagnostic codes 97
 dust detection surface 65
 operating states and lights 68
 replacing 71
 window 73
 zones xxii, 71, 72
light bulbs 74
light stack 74
lockout/tagout
 graphic 2
 guidelines xii
 procedure xiv, xvi, xlii, xliv
lubrication
 brake motor 29
 chain lubrication 56, 78
 drive wheels 40
 general 28

guide wheels 52
pressure wheels 55
take-up bearing 56
wheels and bearings 79

M

machine configurations *see* configurations
maintenance
 checklists 104
manual
 how to use 2
 introduction 1
 navigation 2
 purpose 1
 symbols used in 2
manual brake lever 30
master link 59
motor
 brake pad replacement 37
 replacement 30
 rotation 15
motor drive chain
 adjusting tension 58
motor drive chain tension 57
multimeter 83

N

notice of change iii

O

oil *see* lubrication
operation
 indicator lights 20
 joystick 21
 options 21
 procedure 23
 quick start 23
 stopping 18

Index

P

- page change iii
- parts list
 - navigation
- parts of laser scanner *see* laser scanner
- pressure wheels
 - graphic 78
 - lubrication 55, 79
 - replacing 55
- printing the manual 1

R

- ready indicator lights 20
- replacement parts 99
 - electrical parts 101
 - guards 102
 - labels 103
 - mechanical parts 101
 - parts list
- reporting errors ii
- reset button *see* controls
- restricted zones xxiii
- return goods ii
- roller bearing *see* take-up bearing
- roller height 60
- rotation of motor *see* motor rotation

S

- safety
 - during troubleshooting 81, 82
 - indicators viii
 - inspecting xix
 - labels 103
 - lockout/tagout xii, 2
 - restricted zones xxiii
 - rules ix
 - safety rules viii, xxxvi
 - signal words viii
 - test xviii
 - testing laser scanners xxi
 - testing safety controller xx
 - troubleshooting w/energy xvii

- safety controller
 - diagnostics 90
 - errors 93
 - inspecting 62
 - memory cassette 64
 - operating states 63
 - voltage drops 64
- safety symbols xxv
- safety tests
 - Spanish xlvii
- spare parts, *see* replacement parts
- specifications 9
- stop motion *see* E-stop
- stopping *see* operation

T

- take-up bearing
 - adjusting 56
 - diagram 61
 - lubrication 56
- tension sprocket
 - adjustment 76
 - drive wheel chain 57
 - graphic 76
 - motor drive chain 58
- timing belt 58
- timing relay 87
- troubleshooting
 - electrical problems 87
 - laser scanner problems 97
 - mechanical problems 85
 - perimeter guarding 87
 - safety controller 93
 - safety controller problems 93
 - tools needed 83
- types of oil *see* lubrication

V

- VFD (variable frequency drive)
 - faults 26
 - overview 64
 - troubleshooting 87

Index

W

wheels

drive wheels 40

guide wheels 52

idler wheels 40

pressure wheels 55

window in laser scanner 73